

E-MOBILITY

HIGH VOLTAGE MEASUREMENT TECHNOLOGY

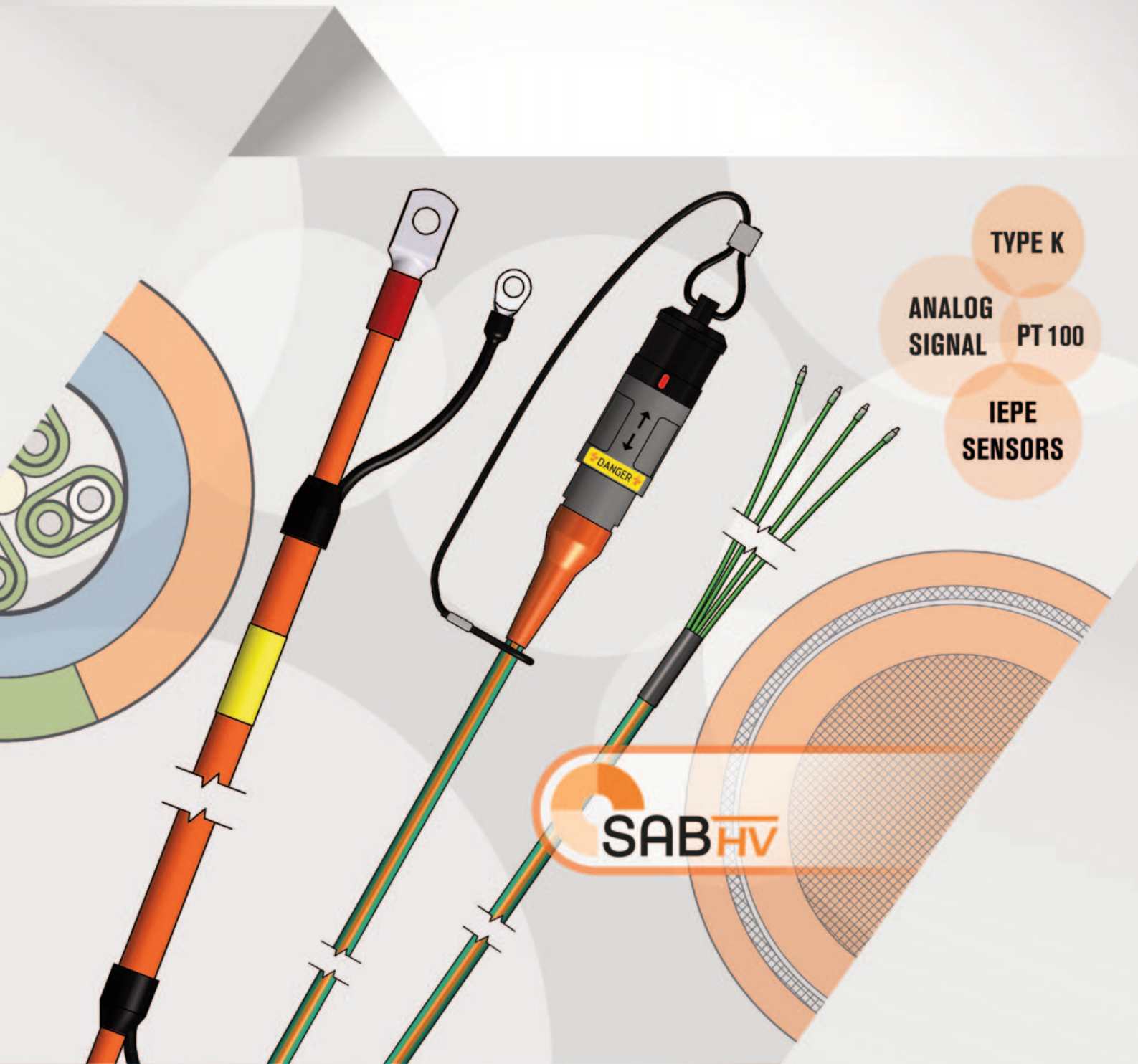

ANALOG
SIGNAL

TYPE K

PT 100

IEPE
SENSORS

SAB HV

Family business in the third generation

75 years of experience in cable and wire manufacturing as well as in temperature measurement technology turned a one-man business into a company with more than 550 employees. We prove our strength every year with more than 1500 special products according to customers' requirements. Each product is a new challenge for our creative technical team. We at **SAB** see ourselves as a manufacturer and a service provider – in the sense of true partnership and the greatest possible customer orientation.

Today, the quality of our products is known and appreciated in more than 100 countries around the world. In all product ranges, we are certified according to DIN EN ISO 9001. Furthermore, we have implemented an environmental management system for our company according to DIN EN ISO 14001, an occupational health and safety management system according to NLF/ILO-OSH and DIN ISO 45001, and an energy management system according to DIN EN ISO 50001.

And also for the future, our slogan is: **"WE GO FORWARD!"**

FOUNDED:	1947 by Peter Bröckskes sen. an independent, medium-sized company.
CEO:	Peter Bröckskes and Sabine Bröckskes-Wetten
PLANT/LOCATION:	In Viersen (Lower Rhine) 110.000 m ² company site. Own manufacturing from copper conductor to outer sheath. VDE approved burnchamber and laboratory within the company.
EMPLOYEES/WORKERS:	Approx. 430 at the plant in Viersen, 550 worldwide
YEARLY SALES:	Approx. 134 Mio. € worldwide
PRODUCTS:	Special Cables Measurement Technology Cable Harnessing

CERTIFICATES AND APPROVALS:



Quality management system acc. to DIN EN ISO 9001 for every manufacturing field

Environmental management system acc. to DIN EN ISO 14001

Occupational health and safety management acc. to NLF/ILO-OSH and DIN ISO 45001

Energy management system acc. to DIN EN ISO 50001

Content

Who we are	2
Reliable temperature measurement at HV components	4
Safe and efficient measurement with CSM measurement technology	5
Product presentation	6-7
1 High voltage temperature measurement technology	
1.1 HV temperature sensor type K	
1.1.1 HV 4-channel thermocouple with FEP insulated thermo channels	8
1.1.2 HV 4-channel thermocouple with PI (polyimide) insulated thermo channels	9
1.1.3 HV 4-channel thermocouple with PFA insulated thermo channels	10
1.1.4 HV 4-channel thermocouple as high temperature version	11
1.1.5 HV 1-channel thermocouple	12
1.1.6 HV 4- and 1-channel extension cable with FEP insulated thermo channels	13
1.2 special thermocouple type K	
1.2.1 surface thermocouple made of twisted thermo cable	14
1.3 HV temperature sensor PT100/PT1000	
1.3.1 HV 2 x PT100/PT1000 resistance thermometer	15
1.3.2 HV 2 x PT100/PT1000 extension cable	16
2 High voltage analogue measurement technology	
2.1 HV connecting cable for acceleration sensors (IEPE)	17
2.2 HV connecting cable for strain gauges	18
2.3 HV 2-channel analogue measuring cable for CSM measurement technology (90 V)	19
2.4 HV 4-channel voltage measuring cable for CSM measurement technology (90 V)	20
2.5 HV 4-channel voltage measuring cable for CSM measurement technology (1000 V)	21
3 High voltage measurement	
3.1 HV measuring cable for DC voltage measurement	22-23
3.2 HV measuring cable for AC voltage measurement	24-25
4 Highly flexible high voltage cables	
4.1 B 110 C - highly flexible Besilen® HV single core, shielded	26-27
4.2 B 107 - highly flexible Besilen® HV single core, unshielded	28
4.3 B 110 C Sense Cable - halogen-free Besilen® Sense cable, shielded	29
5 Test adapter and accessories	
5.1 HV test adapter	30
5.2 further accessories	31
6 Application example	
6.1 Application example for high voltage measuring cables / electric vehicle	32-33
7 Technical Data	
7.1 Glossary	34-35

NEW

Reliable temperature measurement at HV components

For more than 10 years SAB Bröckskes as a worldwide leading cable manufacturer is confronted with the challenges of development and optimization of high-voltage cables as well as high-voltage measurement technology for components in electro-mobility. As a leading manufacturer we optimize our products with regard to the steadily changing requirements and develop continuously new products in the range of temperature measurement technology and wiring for a better and sustainable mobility in future.



4

The measuring system has been especially designed for a safe temperature measurement at high-voltage components and therefore is extremely suitable for the stationary and mobile application in the field of electro-mobility – electric and hybrid vehicle.

The transport sector is the third biggest polluter with greenhouse gases after the energy sector and industry with approximately 20 percent CO₂-emission (2019). The biggest part of transport pollution (94 percent) is caused by traffic. Fuel and diesel powered cars are responsible for 59 percent thereof“.

(German government)

This is the reason why the development of electric drives are of greatest importance for the transport sector. E-mobility has become much more than a niche market.

Safe and efficient measurement with CSM measurement technology

A safe and precise collection of temperatures (thermocouples and PT sensors) and analogue measuring signals can be realized by CSM HV measuring modules in HV environments. CSM HV measuring modules offer tested safety acc. to DIN EN 61010 and due to the multi-level safety concept a measuring chain is set up between sensor and data collection by special sensor cables and HV measuring modules. Furthermore, also standard sensors of LV environments can be used for HV applications.

The measuring modules are appropriate for use in road tests or for test benches as 19" insert module.



For more information, please see www.csm.de



T641 page 15

HV PT2 / HV PT8
temperature measurement
with PT100- and PT1000
resistance thermometers



T141 / T151
page 8-14

HV TH4 evo / HV TH8 evo
temperature measurement
with thermocouples:
NiCr-Ni temperature
input (type K)



T642
page 17

HV IEPE3 FL100
safe measurement
of acceleration,
power and pressure
with IEPE sensors



T644 page 18

HV STG4 pro BS20
for measurements
with strain gauges



T641/T645 page 19-21

HV CAN and ECAT AD measuring modules
for direct voltage measurement and
standard sensors (analogue measurements)

Product presentation

▶ HV SENSORS TYPE K

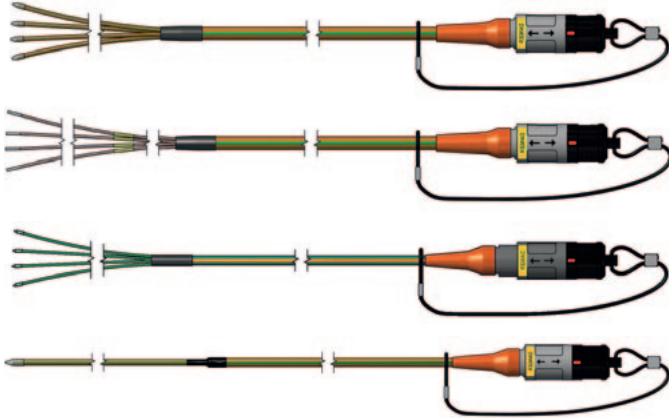

The use of HV type K sensors in HV environments is wide-ranging in vehicle technology and guarantees a safe measurement especially wherever a robust sensor and an exact temperature collection is needed. The sensors are used in HV components as for example inverters, electric motors, HV batteries and power electronics. The HV sensors are appropriate for the stationary as well as for mobile test drives.

▶ HV SENSORS TYPE K HT

HV type K sensors with high temperature design can be used in HV environments of vehicle technology as well as the standard HV sensors especially whenever high process temperatures are expected in the whole environment. This can be for example a thermal hardening process of insulating materials in E-units or other HV components.

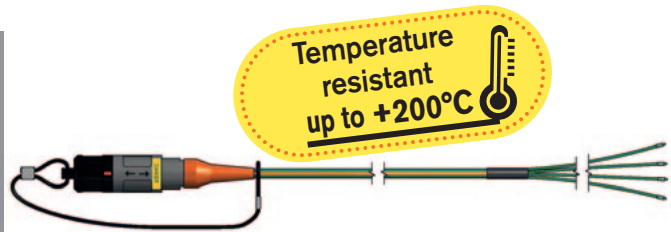

▶ HV SENSORS PT100/1000

The use of HV PT sensors in HV environments is wide ranging in vehicle technology especially whenever a small thermal mass, short response times by full-surface contact as well as a thin construction combined with an exact measurement are required. The application includes among others the temperature collection between the individual cells of a HV battery.

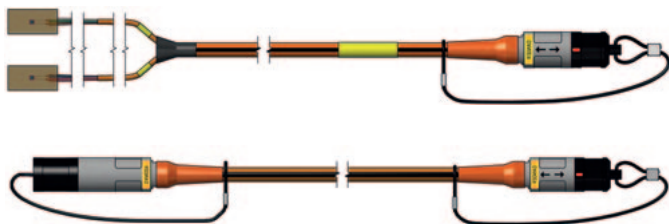

▶ HV TEST ADAPTER

HV test adapters are used for the adaptation of HV sensors in fixed installation and are available for all sensor types in high voltage environments. The test adapter is among others appropriate to test installed sensors for potential equalisation measurements or the fixed mounting in empty housings.

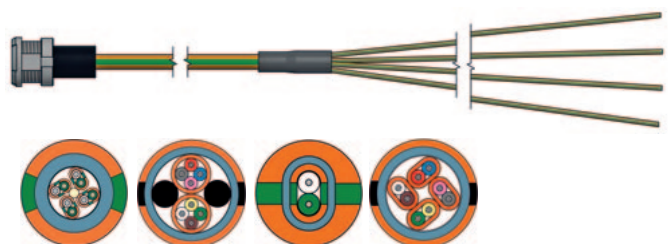

Product presentation

▶ HV SENSOR CABLE ACCELERATION & STRAIN GAUGES



In order to measure acceleration and mechanical tension (strain gauge), HV sensor cables are needed. By the use of these special sensor cables for example tri-axial IEPE acceleration sensors and strain gauges in full and half bridge of the standard low voltage ranges can be used. In combination with the CSM measuring modules HV IEPE3 FL100 and HV STG4 pro BS20 reliable measurements in stationary as well as mobile application for example at test benches can be realised.

▶ HV ANALOGUE MEASURING CABLE AND VOLTAGE MEASURING CABLE

The analogue and voltage measuring cable are especially appropriate for the creation of safe HV measuring chains for example between sensors with analogue voltage output and the CSM measuring modules of series HV AD. By the use of these HV measuring cables combined with the suitable measuring module a voltage up to 90 V and a high voltage up to 1000 V in the stationary test field or mobile road test can be measured.

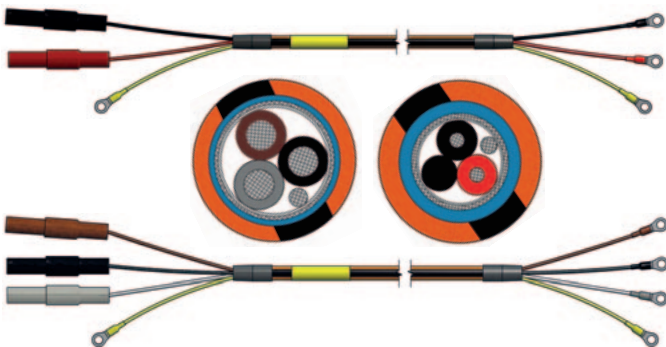

▶ HV VOLTAGE MEASUREMENT

By the use of HV measuring cables (two of three core types) reliable measurements of DC and AC voltage in HV environments can be made. The measuring cables are designed for an operating voltage of up to 1800 V. Furthermore, the cores are colour coded acc. to the voltage type - red and black for plus and minus pole as well as brown, black and grey for the phases L1, L2 and L3.

▶ HIGHLY FLEXIBLE HV CABLES

Our highly flexible HV single cores and sensor cables are especially appropriate for the laying at HV test benches. The HV single cores are an optimal feed line for electric motors or battery systems. By the use of silicone as insulating material combined with a fine stranding, the cables can be installed easily. The screened HV single core offers a 100% EMC protection by a double screening of braid and aluminium foil.



HV temperature sensor type K

HV 4-channel thermocouple with FEP insulated thermo channels

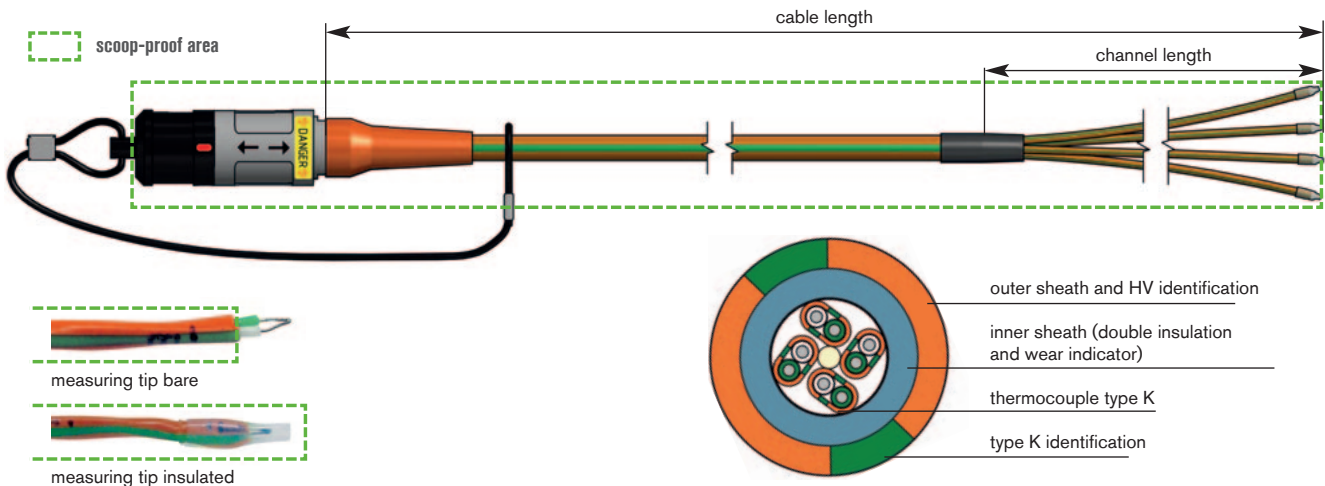

Application range:

Safe HV temperature measurement in HV environments

Connector:

Lemo Redel male connector with orange kink protection sleeve and black protecting cap, 8-pin, B-coded 1000 V AC voltage-stable – IP 67 when connected

Sensor:

Thermocouple:	4 x type K
Limit deviation:	class 1
Measuring point:	bare or electrically insulated (1000 V)
Temperature range single channel:	-40°C / +180°C
Response time:	on request

Cable data:

Connection cable:	HV thermo cable type K
Insulation:	FEP – green and white
Pair sheath:	FEP – orange with green vertical stripes
Inner sheath:	FEP – blue acc. to RAL 5024
Outer sheath:	PUR
Sheath colour:	orange with green vertical stripes
Stranding:	paired construction (for EMC)
Outer diameter:	approx. 6,1 mm
Dielectric strength:	1000 V AC over single channel
Temperature range fixed laying:	-50°C / +150°C
flexible application:	-40°C / +150°C
Special characteristics:	contact protection of individual channels ✓ mechanically rugged ✓

Tests:

► Cable test

over single channel in water bath – 5000 V AC – 5 min – with reference to EN 50264-2-1

► Sensor test

routine test of harnessed connector with reference to standard 61010-1 for measuring devices as well as VDE indications in our in-house ball bath (released by VDE). Control of contact protection towards outside – 3000 V/1 min AC

Issue of HV test certificate with reference to batch number due to optimum traceability

Optional: Test and repair of already used sensors on request

CONFIGURATION EXAMPLES

item no.	connection cable length [mm]	single channel length [mm]				type of measuring tip
		channel 1	channel 2	channel 3	channel 4	
T141-056-330	2400	400	400	400	400	insulated
T141-051-650	2400	400	400	400	400	bare
T141-061-909	3000	580	560	575	355	insulated

Total cable and channel lengths can be realised on customer's request.

SAB identification:

item number, batch number

HV temperature sensor type K

HV 4-channel thermocouple with PI (polyimide) insulated thermo channels

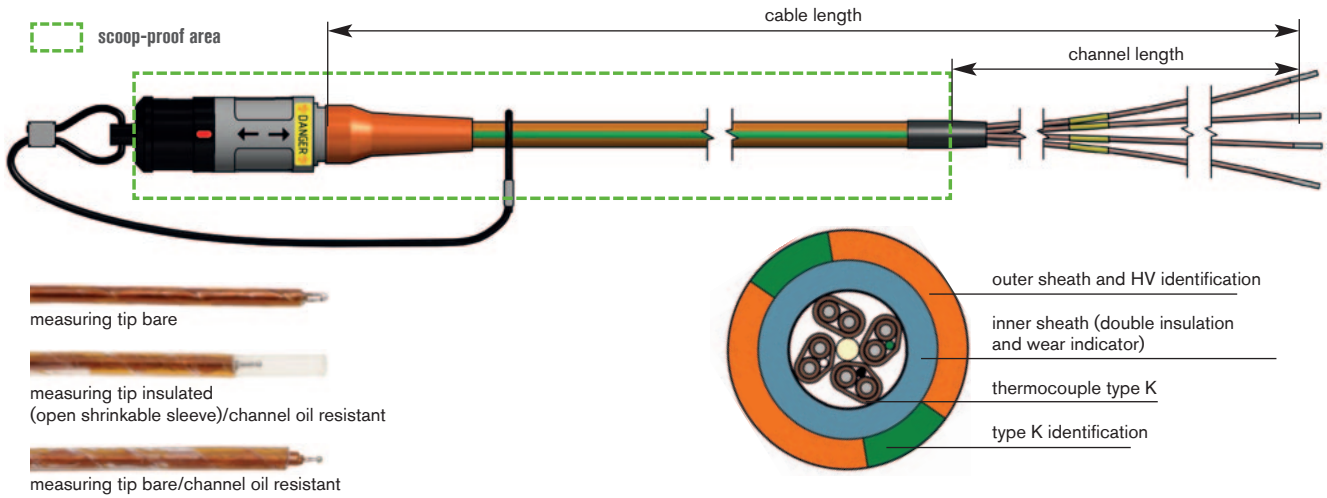

Application range:

Safe HV temperature measurement in HV environments

Connector:

Lemo Redel male connector with orange kink protection sleeve and black protecting cap, 8-pin, B-coded 1000 V AC voltage-stable – IP 67 when connected

Sensor:

Thermocouple:	4 x type K
Limit deviation:	class 1
Measuring point:	bare or electrically insulated (1000 V)
Temperature range single channel:	-40°C / +250°C
Response time:	on request

Cable data:

Connection cable:	HV thermo cable type K
Insulation:	PI foil
Pair sheath:	PI foil
Inner sheath:	FEP – blue acc. to RAL 5024
Outer sheath:	PUR
Sheath colour:	orange with green vertical stripes
Stranding:	optimised in layers
Outer diameter:	approx. 4,5 mm
Dielectric strength:	1000 V AC over inner sheath
Temperature range fixed laying:	-50°C / +150°C
flexible application:	-40°C / +150°C
Special characteristics:	small cable diameter for narrow spaces ✓

Tests:

► Cable test

over inner sheath in water bath – 5000 V AC – 5 min – with reference to EN 50264-2-1

► Sensor test

routine test of harnessed connector with reference to standard 61010-1 for measuring devices as well as VDE indications in our in-house ball bath (released by VDE). Control of contact protection towards outside – 3000 V/1 min AC

Issue of HV test certificate with reference to batch number due to optimum traceability

Optional: Test and repair of already used sensors on request

CONFIGURATION EXAMPLES

item no.	connection cable length [mm]	single channel length [mm]				type of measuring tip
		channel 1	channel 2	channel 3	channel 4	
T141-058-907	2400	400	400	400	400	bare / channel oil resistant
T141-051-415	2400	400	400	400	400	bare
T141-060-960	3000	570	620	560	385	insulated

Total cable and channel lengths can be realised on customer's request.

SAB identification:

item number, batch number



HV temperature sensor type K

HV 4-channel thermocouple with PFA insulated thermo channels

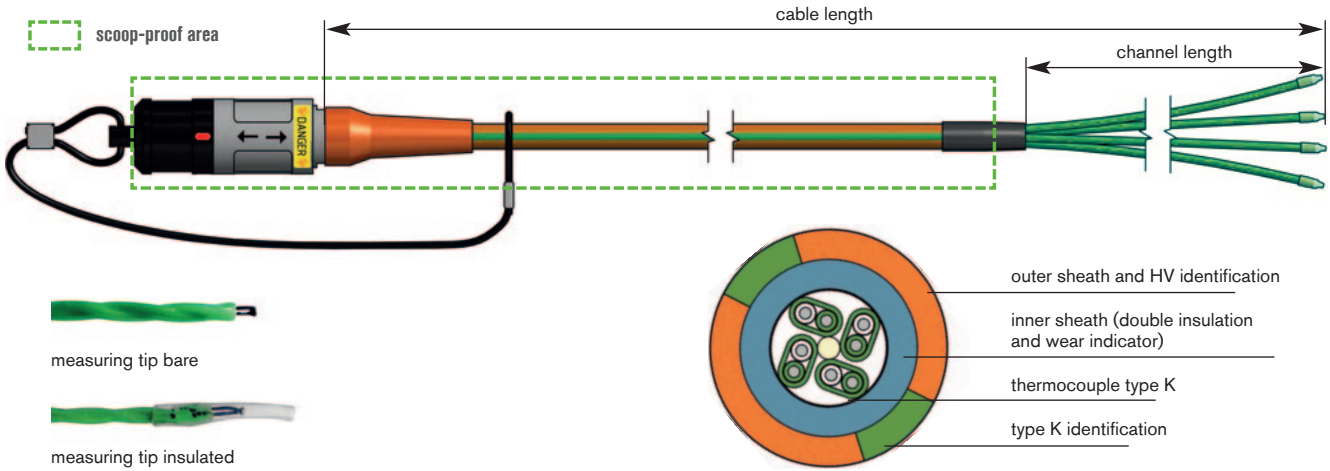

Application range:

Safe HV temperature measurement in HV environments

Connector:

Lemo Redel male connector with orange kink protection sleeve and black protecting cap, 8-pin, B-coded
1000 V AC voltage-stable – IP 67 when connected

Sensor:

Thermocouple:	4 x type K
Limit deviation:	class 1
Measuring point:	bare or electrically insulated (1000 V)
Temperature range single channel:	-40°C / +250°C
Response time:	on request

Cable data:

Connection cable:	HV thermo cable type K
Insulation:	PFA – green and white
Pair sheath:	PFA – green acc. to RAL 6018
Inner sheath:	FEP – blue acc. to RAL 5024
Outer sheath:	PUR
Sheath colour:	orange with green vertical stripes
Stranding:	paired construction (for EMC)
Outer diameter:	approx. 4,4 mm
Dielectric strength:	1000 V AC over inner sheath
Temperature range fixed laying:	-50°C / +150°C
flexible application:	-40°C / +150°C
Special characteristics:	small cable diameter for narrow spaces ✓

Tests:

► Cable test

over single channel in water bath –
5000 V AC – 5 min – with reference to EN 50264-2-1

► Sensor test

routine test of harnessed connector
with reference to standard 61010-1 for measuring devices
as well as VDE indications in our in-house ball bath
(released by VDE). Control of contact protection
towards outside – 3000 V/1 min AC

Issue of HV test certificate with reference to batch number due to optimum traceability

Optional: Test and repair of already used sensors on request

CONFIGURATION EXAMPLES

item no.	connection cable length [mm]	single channel length [mm]				type of measuring tip
		channel 1	channel 2	channel 3	channel 4	
T141-063-016	2400	400	400	400	400	bare
T141-063-018	3000	500	500	500	500	bare
T141-063-019	2400	400	400	400	400	insulated
T141-063-020	3000	500	500	500	500	insulated

Total cable and channel lengths can be realised on customer's request.

SAB identification:

item number, batch number

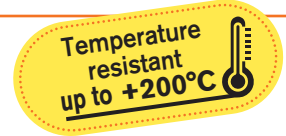

HV temperature sensor type K

HV 4-channel thermocouple as high temperature version

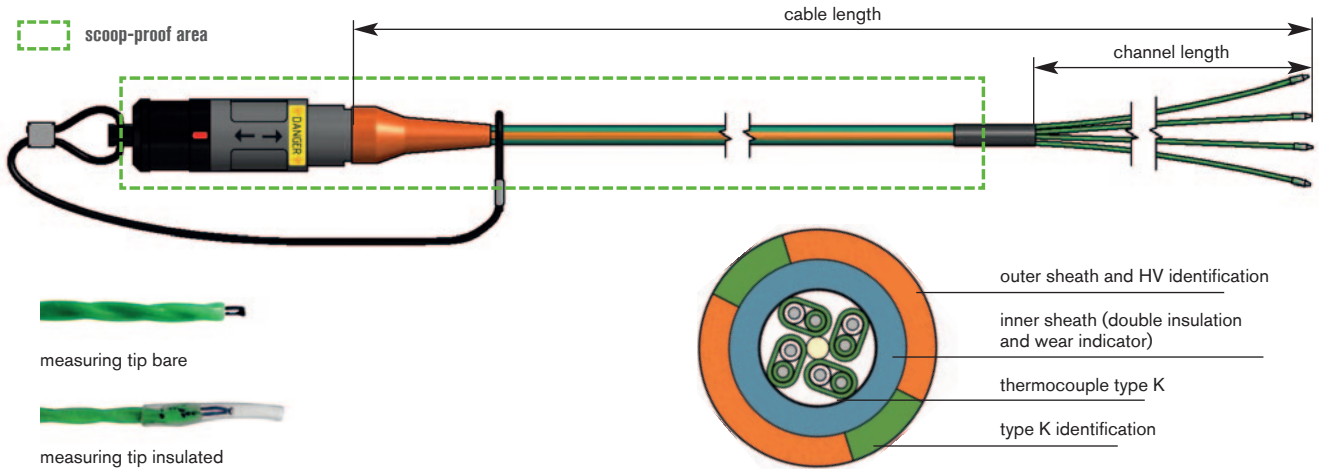

Application range:

Safe HV temperature measurement with ambient temperatures up to + 200°C (for example in hardening processes of impregnated motor windings)

Connector:

Lemo Redel male connector with orange kink protection sleeve and black protecting cap, 8-pin, B-coded 1000 V AC voltage-stable – IP 67 when connected

Sensor:

Thermocouple:	4 x type K
Limit deviation:	class 1
Measuring point:	bare or electrically insulated (1000 V)
Temperature range single channel:	-40°C / +250°C
Response time:	on request

Cable data:

Connection cable:	HV thermo cable type K HT
Insulation:	PFA – green and white
Pair sheath:	PFA – green acc. to RAL 6018
Inner sheath:	FEP – blue acc. to RAL 5024
Outer sheath:	Besilen®
Sheath colour:	orange with green vertical stripes
Stranding:	paired construction (for EMC)
Outer diameter:	approx. 4,4 mm
Dielectric strength:	1000 V AC over inner sheath
Temperature range fixed laying:	-40°C / +220°C
flexible application:	-25°C / +220°C
Special characteristics:	high temperature resistant ✓ highly flexible ✓ small cable diameter for narrow spaces ✓

Tests:

► Cable test

over blue inner sheath in water bath – 5000 V AC – 5 min – with reference to EN 50264-2-1

► Sensor test

routine test of harnessed connector with reference to standard 61010-1 for measuring devices as well as VDE indications in our in-house ball bath (released by VDE). Control of contact protection towards outside – 3000 V/1 min AC

Issue of HV test certificate with reference to batch number due to optimum traceability

Optional: Test and repair of already used sensors on request

CONFIGURATION EXAMPLES

item no.	connection cable length [mm]	single channel length [mm]				type of measuring tip
		channel 1	channel 2	channel 3	channel 4	
T151-061-737	3000	500	500	500	500	insulated
T151-061-736	3000	500	500	500	500	bare

Total cable and channel lengths can be realised on customer's request.

SAB identification:

item number, batch number

HV temperature sensor type K

HV 1-channel thermocouple

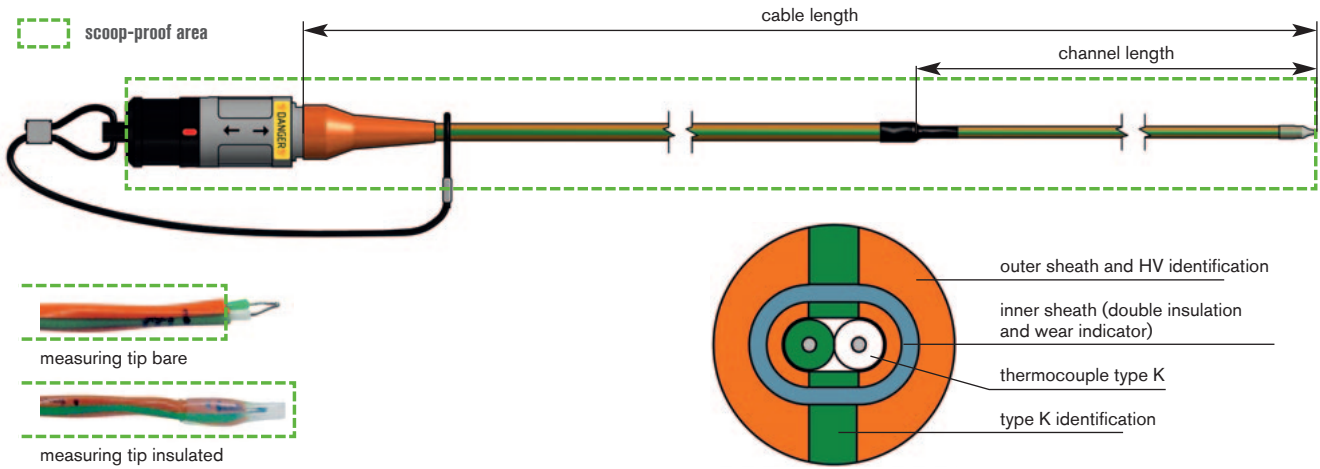

Application range:

Safe HV temperature measurement in HV environments

Connector:

Lemo Redel male connector with orange kink protection sleeve and black protecting cap, 2-pin, C-coded 1000 V AC voltage-stable – IP 67 when connected

Sensor:

Thermocouple:	1 x type K
Limit deviation:	class 1
Measuring point:	bare or electrically insulated (1000 V)
Temperature range single channel:	-40°C / +180°C
Response time:	on request

Cable data:

Connection cable:	HV thermo cable type K
Insulation:	FEP – green and white
Pair sheath:	FEP – orange with green vertical stripes
Inner sheath:	FEP – blue acc. to RAL 5024
Outer sheath:	PUR
Sheath colour:	orange with green vertical stripes
Stranding:	paired construction (for EMC)
Outer diameter:	approx. 3,4 mm
Dielectric strength:	1000 V AC over single channel
Temperature range fixed laying:	-50°C / +150°C
flexible application:	-40°C / +150°C
Special characteristics:	contact protection over single channel ✓

Tests:

► Cable test

over pair sheath in water bath – 5000 V AC – 5 min – with reference to EN 50264-2-1

► Sensor test

routine test of harnessed connector with reference to standard 61010-1 for measuring devices as well as VDE indications in our in-house ball bath (released by VDE). Control of contact protection towards outside – 3000 V/1 min AC

Issue of HV test certificate with reference to batch number due to optimum traceability

Optional: Test and repair of already used sensors on request

CONFIGURATION EXAMPLES

item no.	connection cable length [mm]	single channel length [mm]	type of measuring tip
		channel 1	measuring tip
T141-059-052	2400	400	insulated
T141-058-124	3000	400	bare

Total cable and channel lengths can be realised on customer's request.

SAB identification:

item number, batch number

HV extension cable type K

HV 4- and 1-channel extension cable with FEP insulated thermo channels

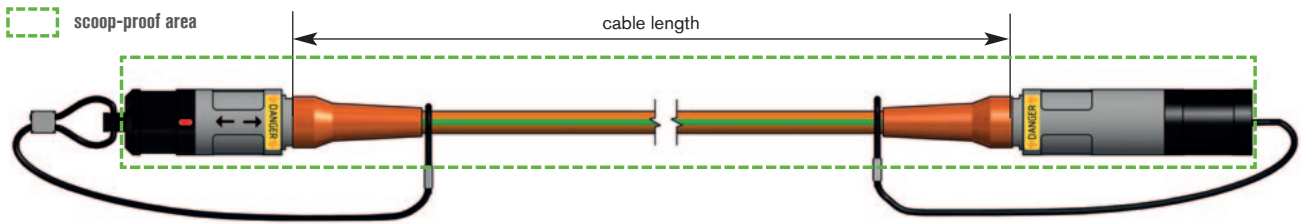

Application range:

Extension of 4- or 1-channel high voltage sensors type K

Connectors:

Lemo Redel connector - male and female, with orange kink protection sleeve and black protecting cap

4-channel:
8-pin, B-coded
1000 V AC voltage-stable - IP 67 when connected

2-channel:
2-pin, C-coded
1000 V AC voltage-stable - IP 67 when connected



Cable data:

	4-channel	1-channel
Connection cable:	HV thermo cable type K	HV thermo cable type K
Insulation:	FEP – green and white	FEP – green and white
Pair sheath:	FEP – orange with green vertical stripes	FEP – orange with green vertical stripes
Inner sheath:	FEP – blue acc. to RAL 5024	FEP – blue acc. to RAL 5024
Outer sheath:	PUR	PUR
Sheath colour:	orange with green vertical stripes	orange with green vertical stripes
Stranding:	paired construction (for EMC)	paired construction (for EMC)
Outer diameter:	approx. 6,1 mm	approx. 3,4 mm
Dielectric strength:	1000 V AC	1000 V AC over single channel
Temperature range		
fixed laying:	-50°C / +150°C	-50°C / +150°C
flexible application:	-40°C / +150°C	-40°C / +150°C
Special characteristics:	contact protection over all components ✓	contact protection over all components ✓

Tests:

► Cable test

over pair sheath in water bath –
5000 V AC – 5 min – with reference to EN 50264-2-1

► Product test

routine test of harnessed connector with reference to standard 61010-1 for measuring devices as well as VDE indications in our in-house ball bath (released by VDE). Control of contact protection towards outside – 3000 V/1 min AC

Issue of HV test certificate with reference to batch number due to optimum traceability

Optional: Test and repair of already used sensors on request

CONFIGURATION EXAMPLES

item no.	connection cable length [mm]	channels
T141-054-030	1000	4
T141-054-143	2000	4
T141-058-575	3000	4
T141-058-576	5000	4

Total lengths can be realised on customer's request.

CONFIGURATION EXAMPLES

item no.	connection cable length [mm]	channels
T141-062-840	1000	1
T141-062-843	3000	1
T141-062-844	5000	1

Total lengths can be realised on customer's request.

SAB identification:

item number, batch number, length

Special thermocouple type K

surface thermocouple made of twisted thermo cable

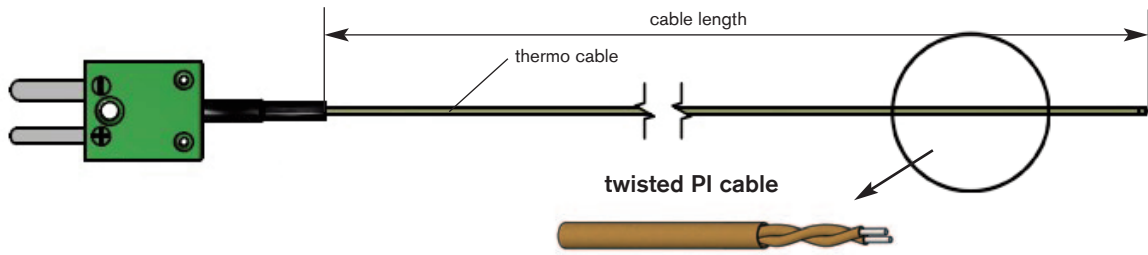

Application range:

for example for temperature collection at Hairpin windings in the stator of E-drives. The scattering effect of electromagnetic radiation from the surrounding copper windings shall not distort the measuring result.

Connector:

e.g. miniature thermo plug type K (as shown in the figures)

Sensor:

Thermocouple:	1 x type K
Limit deviation:	class 1
Measuring point:	see Illustration of measuring tips
Temperature range single channel:	-40°C / +250°C
Response time:	on request

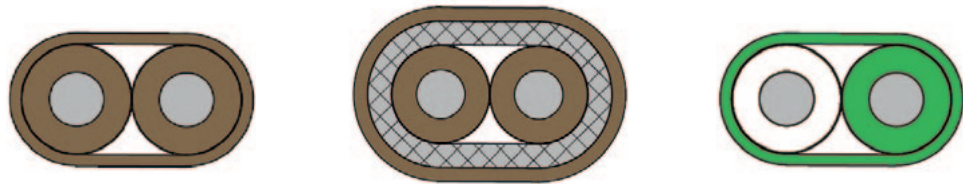
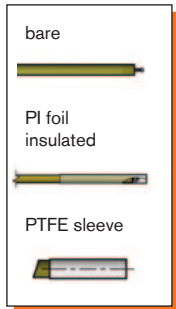

Cable data:

	PI (polyimide)	PI (polyimide)	PFA
Designation:	twisted PI thermo cable	screened and twisted PI thermo cable	twisted PFA thermo cable
Insulation:	PI foil insulation	PI foil insulation	PFA
Outer sheath:	PI foil insulation	PI foil insulation	PFA
Stranding:	paired construction (for EMC)	paired construction (for EMC)	paired construction (for EMC)
Outer diameter:	approx. 0,85 mm	approx. 1,05 mm	approx. 0,80 mm
Temperature range			
fixed laying:	-40°C / +250°C	-40°C / +250°C	-40°C / +250°C
flexible application:	-40°C / +250°C	-40°C / +250°C	-40°C / +250°C

1.2.1

14

CONFIGURATION EXAMPLES

item no.	type	measuring tip	cable	cable length m	connection end
T100-061-046	K	PTFE sleeve	2 x 0,20 mm PI twisted	1.5	miniature thermoplug
T100-061-998	K	PI foil	2 x 0,20 mm PI twisted	2.0	bare
T100-060-628	K	bare	2 x 0,20 mm PI twisted	2.0	miniature thermoplug
T100-060-629	K	bare	2 x 0,20 mm PI twisted	3.0	miniature thermoplug
T100-061-276	K	bare	2 x 0,20 mm PI twisted	1.0	bare

SAB identification:

item number, batch number

HV temperature sensor PT100/PT1000

HV 2 x PT100/PT1000 resistance thermometer

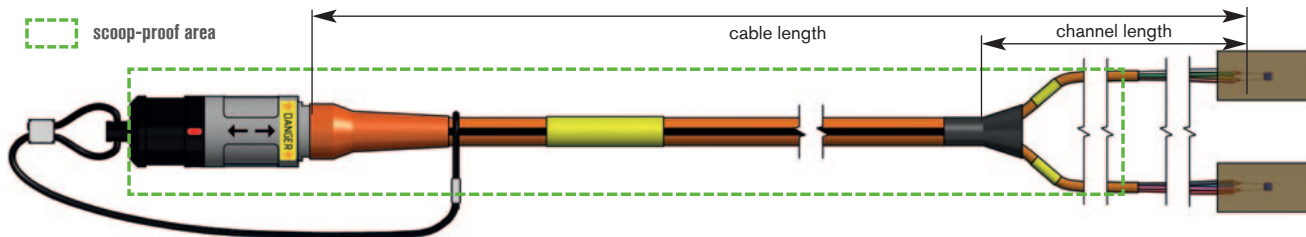

Application range:

Safe HV temperature measurement in HV environments

Connector:

Lemo Redel male connector with orange kink protection sleeve and black protecting cap, 8-pin, C-coded 1000 V AC voltage-stable – IP 67 when connected

Sensor:

Type of sensor:	2 x PT100
Limit deviation:	class A
Wire circuit:	4-wire
Measuring point:	embedded in PI foil adhesive pad
Dimension of sensor:	for example 2,3 mm x 2,0 mm x 0,47 mm (appropriate for pouch cells) or 3,0 mm x 0,80 mm x 0,60 mm
Temperature range single channel:	-30°C / +180°C



Cable data:

	FEP	FEP
Designation:	HV measuring cable – 1 x 8 cores	HV measuring cable – 4 x 2 cores
Insulation:	FEP – acc. to DIN 47100 1-8 (core-Ø 0,45 mm)	FEP – acc. to DIN 47100 1-8
Outer sheath:	PUR	PUR
Stranding:	optimised in layers	optimised in layers
Outer diameter:	approx. 4,6 mm	approx. 7,3 mm
Dielectric strength:	1000 V AC over orange inner sheath	1000 V AC over orange bundle sheath
Temperature range fixed laying:	-40°C / +150°C	-40°C / +150°C
flexible application:	-40°C / +150°C	-40°C / +150°C

Tests:

► Cable test

core/core – 2500 V AC - 5 min
over orange bundle sheath –
5000 V AC – 5 min – with reference to EN 50264-2-1

► Sensor test

routine test of harnessed connector with reference to standard 61010-1 for measuring devices as well as VDE indications in our in-house ball bath (released by VDE). Control of contact protection towards outside – 3000 V/1 min AC

Issue of HV test certificate with reference to batch number due to optimum traceability

Optional: Test and repair of already used sensors on request

CONFIGURATION EXAMPLES

item no.	connection cable length [mm]	single channel length [mm]	
		channel 1	channel 2
T641-060-817	2000	70	70
T641-060-870	5000	700	700

Total cable and channel lengths can be realised on customer's request.

SAB identification:

item number, batch number

HV extension cable PT100/PT1000

HV 2 x PT100/PT1000 extension cable

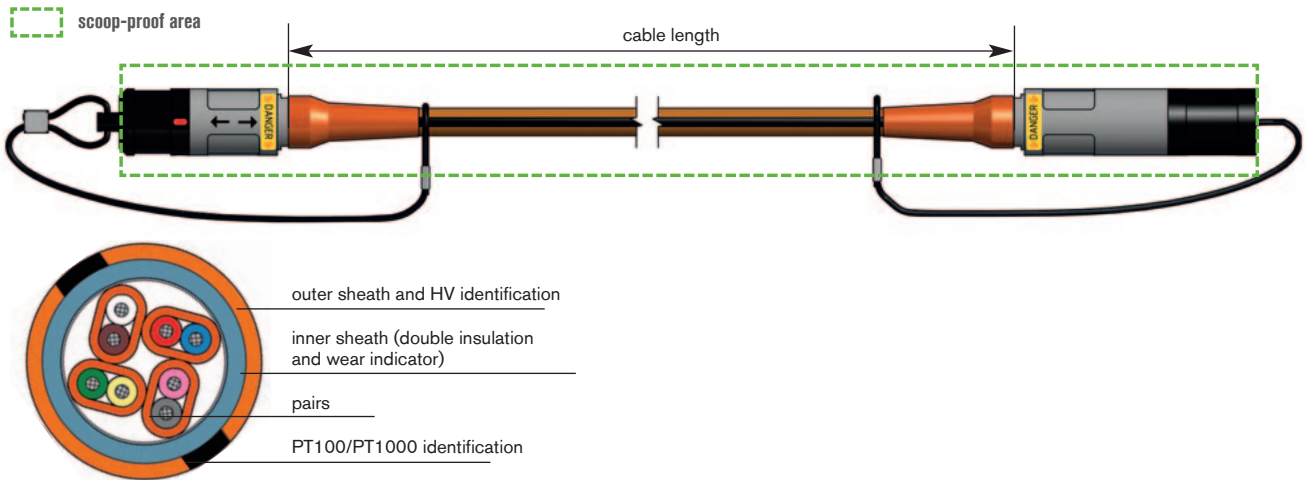

Application range:

Extension of HV 2 x Pt 100 sensors

Connectors:

Lemo Redel male connector -
male/female connector with orange kink protection sleeve
and black protecting cap, 8-pin, C-coded
1000 V AC voltage-stable – IP 67 when connected

CONFIGURATION EXAMPLES

item no.	connection cable length [mm]
T641-056-497	1000
T641-058-117	3000
T641-058-574	5000

Total cable and channel lengths can be realised on customer's request.

Cable data:

Connection cable:	HV measuring cable
Insulation:	FEP – acc. to DIN 47100 1-8
Pair sheath:	FEP – orange acc. to RAL 2004
Inner sheath:	PUR – blue acc. to RAL 5024
Outer sheath:	PUR
Sheath colour:	orange with green vertical stripes
Stranding:	optimised in layers
Outer diameter:	approx. 7,4 mm
Dielectric strength:	1000 V AC over pair sheath
Temperature range	
fixed laying:	-40°C / +150°C
flexible application:	-40°C / +150°C
Special characteristics:	contact protection over all components ✓

1.3.2

16

Tests:

► Cable test

core/core – 2500 V AC - 5 min
over pair sheath –
5000 V AC – 5 min – with reference to EN 50264-2-1

► Product test

routine test of harnessed connector
with reference to standard 61010-1 for measuring devices
as well as VDE indications in our in-house ball bath
(released by VDE). Control of contact protection
towards outside – 3000 V/1 min AC

Issue of HV test certificate with reference to batch number due to optimum traceability

Optional: Test and repair of already used sensors on request

SAB identification:

item number, batch number, length

HV connecting cable for acceleration sensors (IEPE)

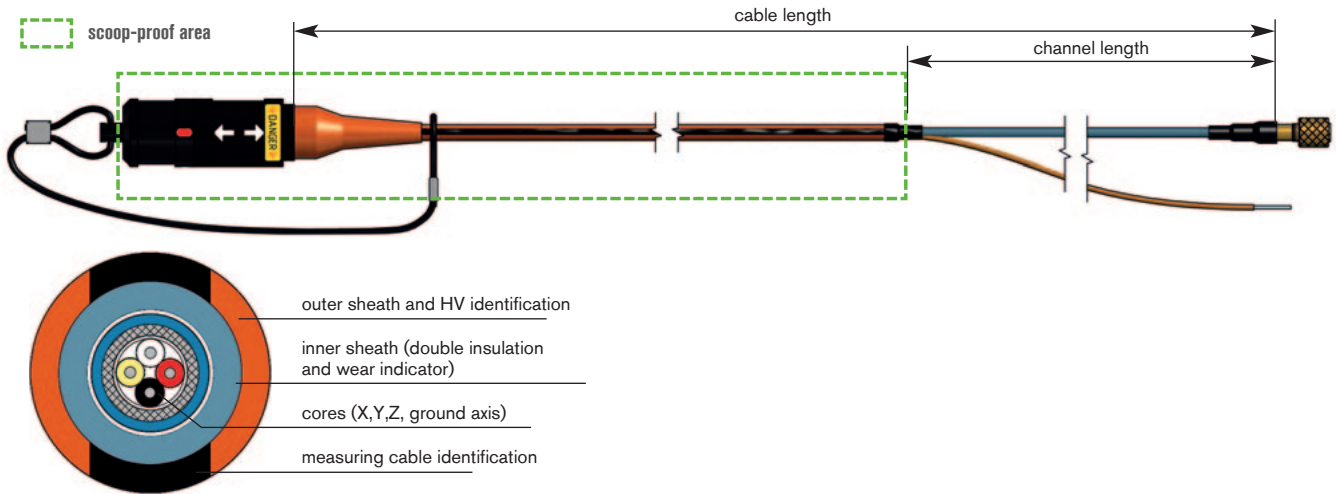

Application range:

Safe HV acceleration measurement for example with CSM HV IEPE3 FL 100 measuring module

Connector:

Lemo Redel male connector with orange kink protection sleeve and black protecting cap, 8-pin, C-coded 1000 V AC voltage-stable – IP 67 when connected

Sensor connection side:

Connector:	4-pin ¼-28 UNF socket for the connection of a triaxial IEPE acceleration sensor (also with 4-pin 8-36 UNF and 4-pin M4,5)
Screen:	led out in bundle and insulated with shrinkable sleeve
Temperature range bundle channel:	-55°C / +250°C

Cable data:

Connection cable:	HV IEPE sensor cable
Core insulation:	PFA – red, white, black, yellow
Bundle sheath:	PFA – blue acc. to RAL 5015
Inner sheath:	PUR – blue acc. to RAL 5024
Outer sheath:	PUR
Sheath colour:	orange with black vertical stripes
Stranding:	optimised in layers
Outer diameter:	approx. 4,3 mm
Dielectric strength:	1000 V AC over second inner sheath
Temperature range	
fixed laying:	-50°C / +150°C
flexible application:	-40°C / +150°C
Special characteristics:	contact protection see presentation ✓

Tests:

► Cable test

core/core – 600 V AC – 1 min – acc. to IEC 60584-1 over second inner sheath in water bath – 5000 V AC – 5 min – with reference to EN 50264-2-1

► Product test

routine test of harnessed connector with reference to standard 61010-1 for measuring devices as well as VDE indications in our in-house ball bath (released by VDE). Control of contact protection towards outside – 3000 V/1 min AC

Issue of HV test certificate with reference to batch number due to optimum traceability

Optional: Test and repair of already used sensors on request

CONFIGURATION EXAMPLES

item no.	connection cable length [mm]	single channel length [mm]		male connector
		channel 1	grounding	
T642-062-666	3000	100	200	4-Pin ¼ -28 UNF
T642-062-794	6000	100	200	4-Pin ¼ -28 UNF
T642-062-635	3000	100	200	4-Pin 8-36 UNF

SAB identification:

item number, batch number

Total cable and channel lengths can be realised on customer's request.

HV connecting cable for strain gauges

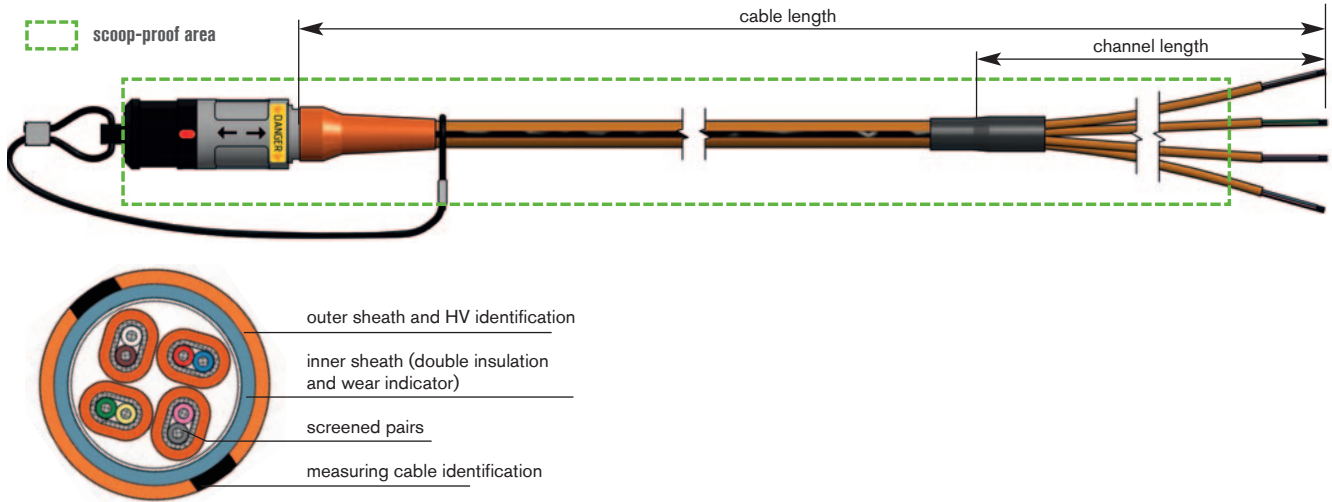

Application range:

Safe HV strain gauge measurement (full / half bridge)
for example with CSM HV STG4 pro BS20
measuring module

Connector:

Lemo Redel male connector with orange kink protection
sleeve and black protecting cap, 8-pin, E-coded
1000 V AC voltage-stable – IP 67 when connected

Connection end:

Outer sheath:	122 mm stripped
Pair sheath:	22 mm
Open end:	2 mm
Connection:	tinned
Screen:	small cable diameter for narrow spaces
Temperature range single channel:	-55°C / +180°C

Cable data:

Connection cable:	HV strain gauge sensor cable
Core insulation:	FEP – acc. to DIN 47100 1-8 (core-Ø 0,55 mm)
Screen:	tinned copper braiding incl. drain wire
Pair sheath:	FEP – orange acc. to RAL 2004
Inner sheath:	PUR – blue acc. to RAL 5024
Outer sheath:	PUR
Sheath colour:	orange with black vertical stripes
Stranding:	paired construction (for EMC)
Outer diameter:	approx. 7,4 mm
Dielectric strength:	1000 V AC over pair sheath
Temperature range fixed laying:	-50°C / +150°C
flexible application:	-40°C / +150°C

Tests:

► Cable test

core/core – 600 V AC – 1 min – acc. to IEC 60584-1
over pair sheath in water bath –
5000 V AC – 5 min – with reference to EN 50264-2-1

► Product test

routine test of harnessed connector
with reference to standard 61010-1 for measuring devices
as well as VDE indications in our in-house ball bath
(released by VDE). Control of contact protection
towards outside – 3000 V/1 min AC

Issue of HV test certificate with reference to batch number due to optimum traceability

Optional: Test and repair of already used sensors on request

CONFIGURATION EXAMPLES

item no.	connection cable length [mm]	single channel Length [mm]			connection type
		Length sheath	Length pair	Length core	connection
T644-061-009	2000	122	22	2	tinned
T644-061-014	3000	122	22	2	tinned

Total cable and channel lengths can be realised on customer's request.

SAB identification:

item number, batch number

HV analogue measuring cable

HV 2-channel analogue measuring cable for CSM measurement technology (90 V)

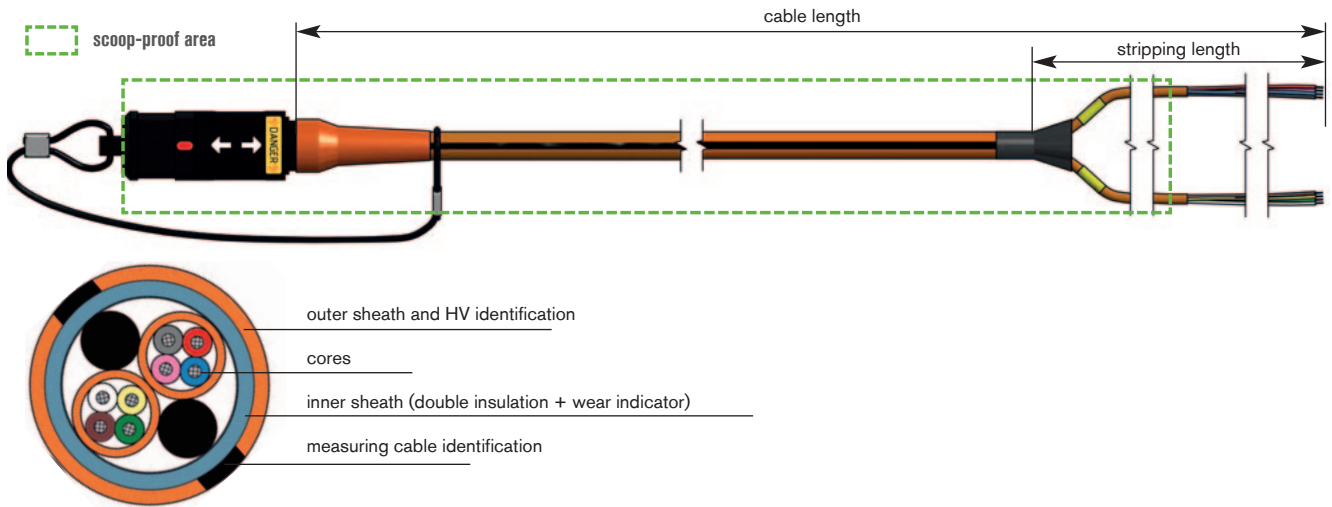

Application range:

Safe HV analogue measurements with standard sensors combined with CSM measuring modules
 HV AD2 IF20, HV AD4 IF20 & HV AD4 IF1000

Connector:

Lemo Redel male connector with orange kink protection sleeve and black protecting cap, 8-pin, C-coded
 1000 V AC voltage-stable – IP 67 when connected

Connection end:

(stripping lengths)

Outer sheath:	100 mm
Pair sheath:	10 mm
Open end:	2 mm
Connection:	tinned

Cable data:

Connection cable:	HV measuring cable
Core insulation:	FEP – acc. to DIN 47100 1-8
Pair sheath:	FEP – orange acc. to RAL 2004
Inner sheath:	PUR – blue acc. to RAL 5024
Outer sheath:	PUR
Sheath colour:	orange with black vertical stripes
Stranding:	optimised in layers
Outer diameter:	approx. 7,3 mm
Dielectric strength:	1000 V AC over orange bundle sheath
Temperature range	
fixed laying:	-50°C / +150°C
flexible application:	-40°C / +150°C

Tests:

► Cable test

core/core – 600 V AC - 1 min - acc. to IEC 60584-1
 over orange bundle sheath –
 5000 V AC – 5 min – with reference to EN 50264-2-1

► Product test

routine test of harnessed connector
 with reference to standard 61010-1 for measuring devices
 as well as VDE indications in our in-house ball bath
 (released by VDE). Control of contact protection
 towards outside – 3000 V/1 min AC

Issue of HV test certificate with reference to batch number due to optimum traceability

Optional: Test and repair of already used sensors on request

CONFIGURATION EXAMPLES

item no.	connection cable length [mm]	single channel length [mm]		
		sheath	pair	core
T641-056-710	2000	100	10	2
T641-056-711	3000	100	10	2

Total cable and channel lengths can be realised on customer's request.

SAB identification:

item number, batch number

HV voltage measuring cable (90 V)

HV 4-channel voltage measuring cable for CSM measurement technology (90 V)

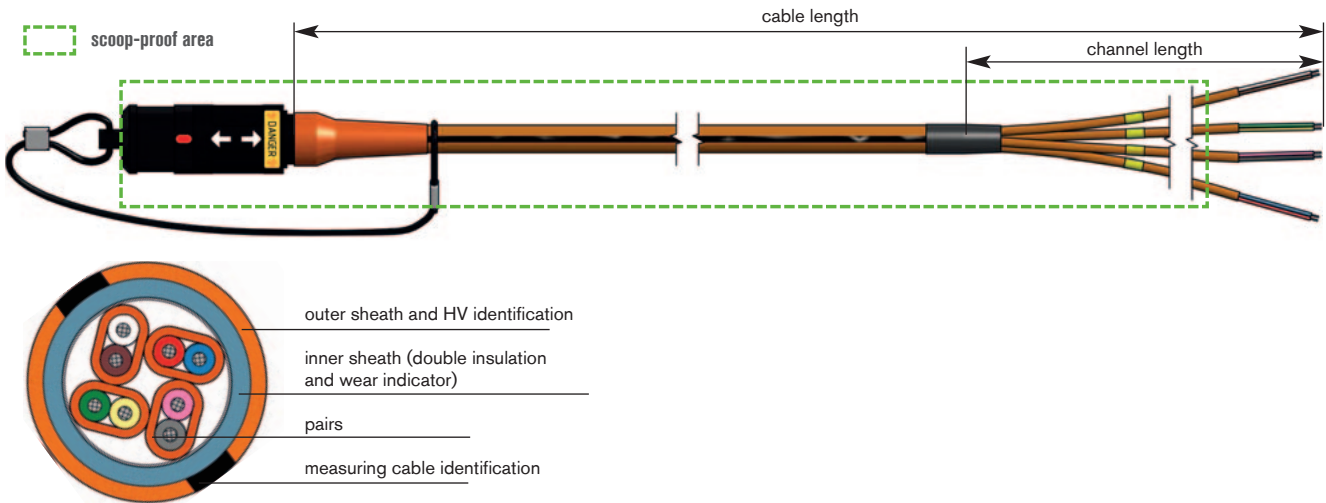

Application range:

Safe HV measurements of analogue voltage combined with CSM measuring modules HV AD4 OW20, HV AD8 OW20 & HV AD4 OW1000*

*test bench & road test

Connector:

Lemo Redel male connector with orange kink protection sleeve and black protecting cap, 8-pin, B-coded 1000 V AC voltage-stable – IP 67 when connected

Connection end:

(stripping lengths)

Outer sheath:	122 mm stripped
Pair sheath:	22 mm
Open end:	2 mm
Connection:	tinned
Temperature range single channel:	-55°C / +180°C

Cable data:

Connection cable:	HV measuring cable
Core insulation:	FEP – acc. to DIN 47100 1-8
Pair sheath:	FEP – orange acc. to RAL 2004
Inner sheath:	PUR – blue acc. to RAL 5024
Outer sheath:	PUR
Sheath colour:	orange with black vertical stripes
Stranding:	paired construction (for EMC)
Outer diameter:	approx. 7,4 mm
Dielectric strength:	1000 V AC over pair sheath
Temperature range fixed laying:	-50°C / +150°C
flexible application:	-40°C / +150°C
Special characteristics:	contact protection also over individual channels ✓

Tests:

► Cable test

core/core – 2500 V AC - 5 min
over pair sheath –
5000 V AC – 5 min – with reference to EN 50264-2-1

► Product test

routine test of harnessed connector with reference to standard 61010-1 for measuring devices as well as VDE indications in our in-house ball bath (released by VDE). Control of contact protection towards outside – 3000 V/1 min AC

Issue of HV test certificate with reference to batch number due to optimum traceability

Optional: Test and repair of already used sensors on request

CONFIGURATION EXAMPLE

item no.	connection cable length [mm]	single channel length [mm]			connection type
		sheath	pair	core	connection
T645-062-738	2000	122	22	2	tinned

Total cable and channel lengths can be realised on customer's request.

SAB identification:

item number, batch number

HV voltage measuring cable (1000 V)

HV 4-channel voltage measuring cable for CSM measurement technology (1000 V)

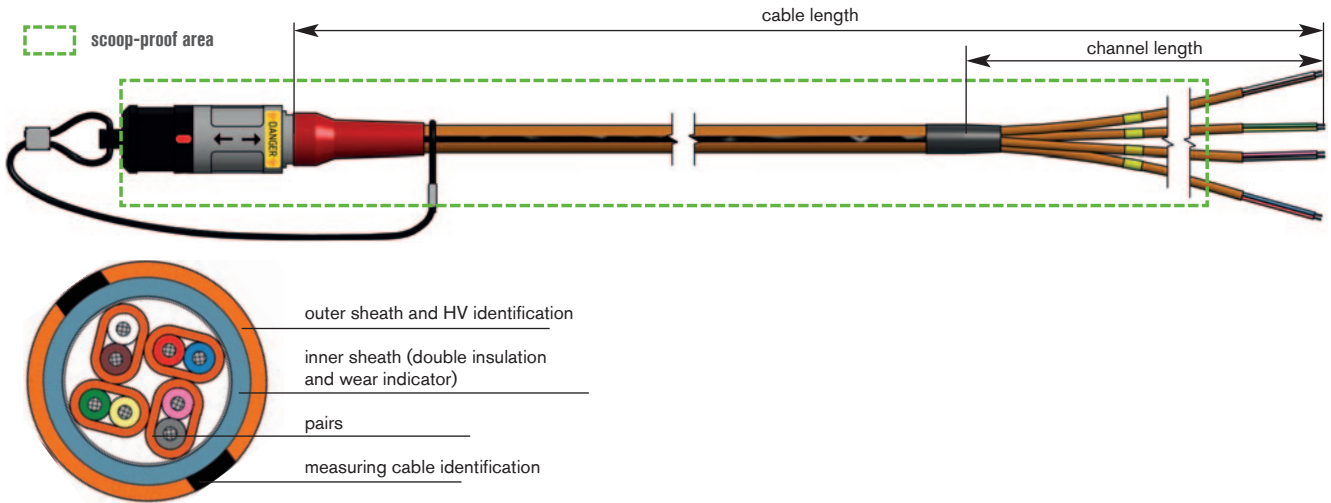

Application range:

Safe HV measurements of high voltage combined with CSM measuring modules HV AD4 XW1000* & HV AD4 XW20

*test bench & road test

Connector:

Lemo Redel male connector with red kink protection sleeve and black protecting cap, 8-pin, D-coded 1000 V AC voltage-stable – IP 67 when connected

Connection end:

(stripping lengths)

Outer sheath:	122 mm stripped
Pair sheath:	22 mm
Open end:	2 mm
Connection:	tinned
Temperature range single channel:	-55°C / +180°C

Cable data:

Connection cable:	HV measuring cable
Core insulation:	FEP – acc. to DIN 47100 1-8
Pair sheath:	FEP – orange acc. to RAL 2004
Inner sheath:	PUR – blue acc. to RAL 5024
Outer sheath:	PUR
Sheath colour:	orange with black vertical stripes
Stranding:	paired construction (for EMC)
Outer diameter:	approx. 7,4 mm
Dielectric strength:	1000 V AC over pair sheath
Temperature range fixed laying:	-50°C / +150°C
flexible application:	-40°C / +150°C
Special characteristics:	contact protection also over individual channels ✓

Tests:

► Cable test

core/core – 2500 V AC - 5 min
over pair sheath –
5000 V AC – 5 min – with reference to EN 50264-2-1

► Product test

routine test of harnessed connector with reference to standard 61010-1 for measuring devices as well as VDE indications in our in-house ball bath (released by VDE). Control of contact protection towards outside – 3000 V/1 min AC

Issue of HV test certificate with reference to batch number due to optimum traceability

Optional: Test and repair of already used sensors on request

CONFIGURATION EXAMPLE

item no.	connection cable length [mm]	single channel length [mm]			connection type
		sheath	pair	core	connection
T645-062-695	2000	122	22	2	tinned
T645-063-151	3000	122	22	2	tinned

Total cable and channel lengths can be realised on customer's request.

SAB identification:

item number, batch number

HV measuring cable (DC)

for DC voltage measurement



Marking for HV connecting cable 38339800:

SAB BRÖCKSKES · D-VIERSEN · HV-Messleitung (2x0,25mm²) CE

Application range: The high voltage measuring cable is used in the development of electric vehicles where scoop-proof testing and measuring of up to 1800 V DC operating voltage and application in the HV environment of electromobility take place. Examples of applications are HV power electronics, HV batteries, electric motors, inverters, etc. High voltage measuring cables are used on the test benches and in test vehicles.

Construction:

Conductor:	tinned copper strands, extra fine wires
Core insulation:	FEP
Colour code:	red and black
Stranding:	together with tinned copper drain wire, AWG 24
Screen:	alu foil and tinned copper braiding
Inner sheath:	FEP - blue acc. to RAL 5024
Outer sheath:	PUR
Sheath colour:	orange with black vertical stripes

Outstanding features:

- temperature resistance up to +150 °C (up to 3000 hours)
- high flexibility
- high abrasion resistance
- easy harnessing

Technical data:

Scoop-proof:	1000 V DC over blue inner sheath
Testing voltage:	5000 V AC over blue inner sheath
Operating voltage:	U _o 1000 V DC
Operating voltage:	U 1800 V DC
Testing voltage:	core/core 5000 V AC core/screen 5000 V AC
Min. bending radius	
fixed laying:	5 x d
flexible application:	10 x d
Temperature range	
fixed laying:	-50/+125 °C
flexible application:	-40/+125 °C
short time use:	+150 °C (up to 3000 h)
Absence of harmful substances:	acc. to RoHS directive of the European Union

item no.	no. of cores x cross section n x mm ²	outer-ø approx. mm	copper figure kg/km	cable weight ≈ kg/km	ohmic resistance max. Ω/km
3833-9800	2 x 0,25	6,5	21,3	58	80,0
3833-9819	2 x 0,34	6,7	24,9	63	58,8
3833-9801	2 x 0,50	7,1	28,1	70	40,1
3833-9802	2 x 1,00	7,8	42,5	90	20,0
3833-9803	2 x 1,50	8,4	55,8	108	13,7

Other dimensions and colours are possible on request.

Possible on request:

As harnessed measuring cable
with connected lab plugs
to collect the voltage at HV components
- see next page -

HV measuring cable (DC) for DC voltage measurement (as cable harness)

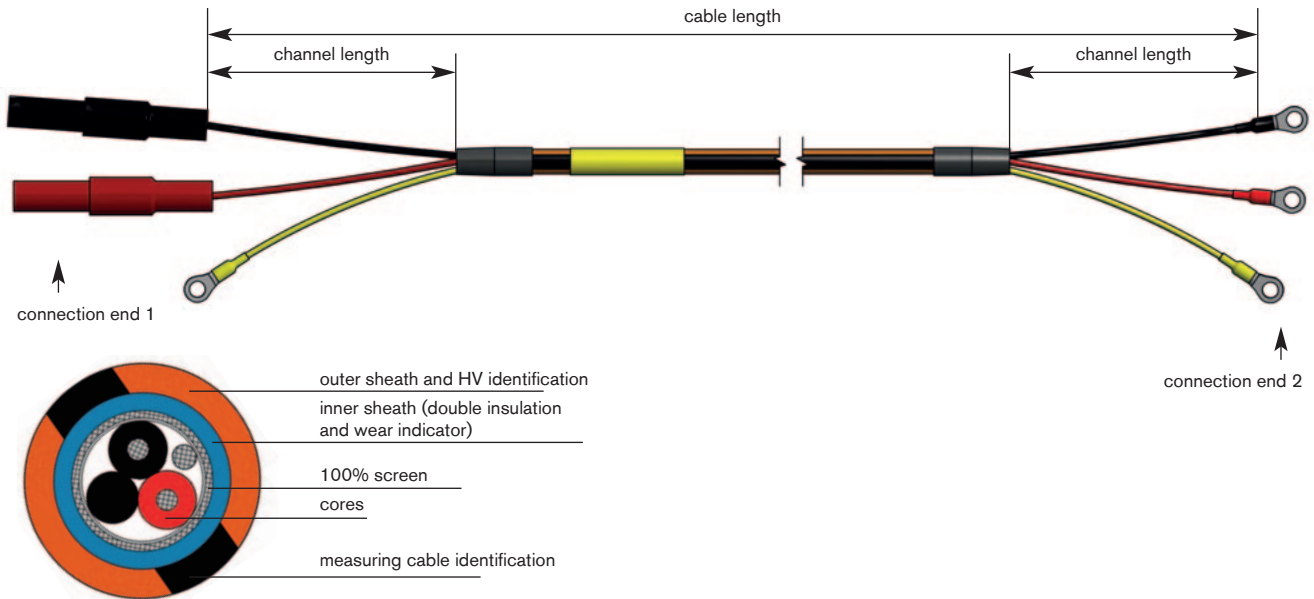

Application range:

Safe HV measurement of DC voltages

Connectors:

Safety lab plugs 1000 V, CAT III, red and black, 4 mm cable lug M4

Connection end:

Stripping length:	250 mm
Screen:	led out with filler and insulated with shrinkable sleeve
Temperature range of single core:	-55°C / +180°C

Cable data:

Connection cable:	HV measuring cable
Core insulation:	FEP – red and black
Stranding:	together with tinned copper drain wire, AWG 24
Screen:	100% screen with alu foil and braiding
Inner sheath:	PUR – blue acc. to RAL 5024
Outer sheath:	PUR
Sheath colour:	orange with black vertical stripes
Outer diameter:	see table on page 22
Scoop-proof:	1000 V DC over blue inner sheath
Operating voltage:	1800 V DC
Temperature range	
fixed laying:	-50°C / +125°C
flexible application:	-40°C / +125°C
short time use:	+150°C (up to 3000 h)

CONFIGURATION EXAMPLE

item no.	connection cable length [mm]	single channel length [mm]		
		channel 1	channel 2	safety lab plugs + M4 cable lugs
T645-062-912	6500	250	250	

Total cable and channel lengths can be realised on customer's request.

SAB identification:

item number, batch number

HV measuring cable (AC)

for AC voltage measurement



Marking for HV connecting cable 38339813:

SAB BRÖCKSKES · D-VIERSEN · HV-Messleitung (3x1,50mm²) · CE

Application range: The high voltage measuring cable is used in the development of electric vehicles where scoop-proof testing and measuring of up to 1800 V DC operating voltage and application in the HV environment of electromobility take place. Examples of applications are HV power electronics, HV batteries, electric motors, inverters, etc. High voltage measuring cables are used on the test benches and in test vehicles.

Construction:

Conductor:	tinned copper strands, extra fine wires
Core insulation:	FEP
Colour code:	brown, black, grey
Stranding:	together with tinned copper drain wire, AWG 24
Screen:	alu foil and tinned copper braiding
Inner sheath:	FEP - blue acc. to RAL 5024
Outer sheath:	PUR
Sheath colour:	orange with black vertical stripes

Outstanding features:



- temperature resistance up to +150 °C (up to 3000 hours)
- high flexibility
- high abrasion resistance
- easy harnessing

Technical data:

Scoop-proof:	1000 V DC over blue inner sheath
Testing voltage:	5000 V AC over blue inner sheath
Operating voltage:	core/core 1800 V DC core/core 1000 V AC
Testing voltage:	core/core 5000 V AC core/screen 5000 V AC
Min. bending radius	
fixed laying:	5 x d
flexible application:	10 x d
Temperature range	
fixed laying:	-50/+125 °C
flexible application:	-40/+125 °C
short time use:	+150 °C (up to 3000 h)
Temperature range of cores:	up to +180 °C (short time use up to +205 °C)
Oil resistance:	very good - TMPU acc. to EN 50363-10-2 + VDE 0207-363-10-2
Absence of harmful substances:	acc. to RoHS directive of the European Union

item no.	no. of cores x cross section n x mm ²	outer-ø approx. mm	copper figure kg/km	cable weight ≈ kg/km	ohmic resistance max. Ω/km
38339820	3 x 0,25	6,8	25,5	66	80,0
38339816	3 x 0,34	7,0	28,3	71	58,8
38339815	3 x 0,50	7,4	34,5	81	40,1
38339814	3 x 1,00	8,1	53,3	106	20,0
38339813	3 x 1,50	8,8	71,7	130	13,7

Other dimensions and colours are possible on request.

Possible on request:

As harnessed measuring cable
with connected lab plugs
to collect the voltage at HV components
- see next page -



HV measuring cable (AC) for AC voltage measurement (as cable harness)

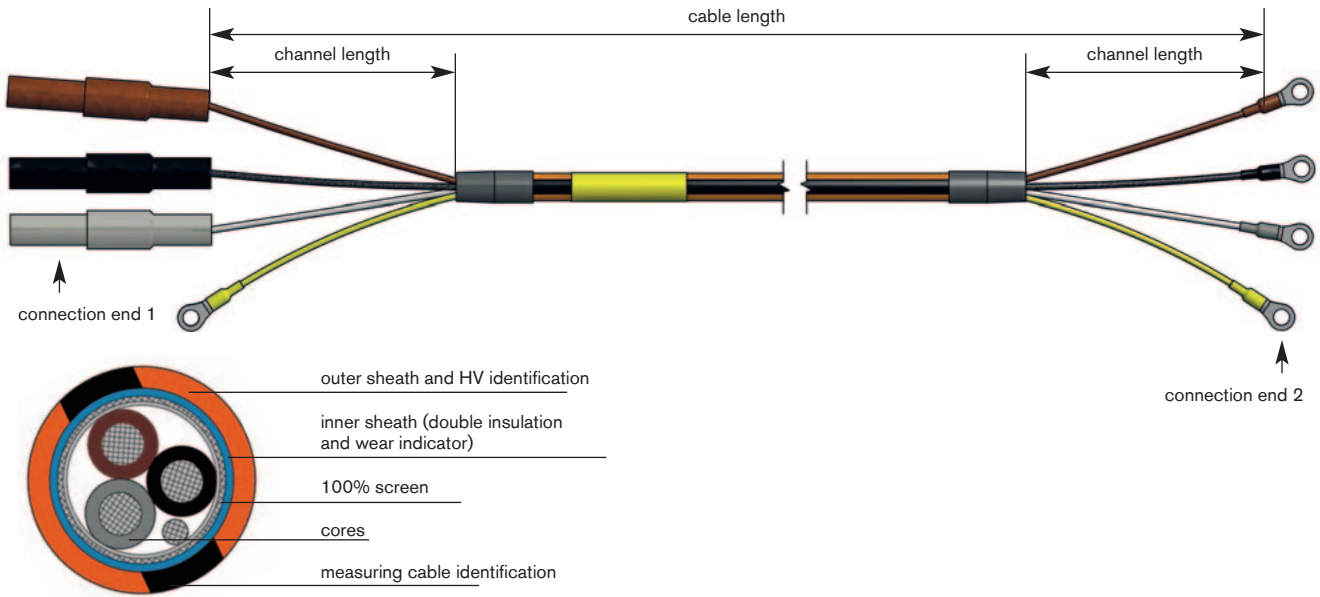

Application range:

Safe HV measurement of AC voltages

Connectors:

Safety lab plugs 1000 V, CAT III,
brown, grey and black, 4 mm cable lug M4

Connection end:

Stripping length:	250 mm
Screen:	led out with filler and insulated with shrinkable sleeve
Temperature range of single core:	-55°C / +180°C

Cable data:

Connection cable:	HV measuring cable
Core insulation:	FEP – brown, black and grey
Stranding:	together with tinned copper drain wire, AWG 24
Screen:	100% screen with alu foil and braiding
Inner sheath:	PUR – blue acc. to RAL 5024
Outer sheath:	PUR
Sheath colour:	orange with black vertical stripes
Outer diameter:	see table on page 24
Scoop-proof:	1000 V DC over blue inner sheath
Operating voltage:	1800 V DC
Temperature range	
fixed laying:	-50°C / +125°C
flexible application:	-40°C / +125°C
short time use:	+150°C (up to 3000 h)

CONFIGURATION EXAMPLE

item no.	connection cable length [mm]	stripping length [mm]		
		connection 1	connection 2	safety lab plugs + M4 cable lugs
T645-062-913	6500	250	250	

Total cable and channel lengths can be realised on customer's request.

SAB identification:

item number, batch number

HIGHLY FLEXIBLE HIGH VOLTAGE CABLE

B 110 C

highly flexible Besilen® HV single core, shielded, cULus recognized

Nominal voltage up to
Uo/U 1.8/3 kV AC



Style 30123 AWM I/II A/B 150°C 3000V FT1 FT2

Marking for B 110 C 01109507:

SAB BRÜCKSKES · D-VIERSEN · B 110 C Uo/U 1,8/3 kV 95,0mm² cULus AWM Style 30123 AWM I/II A/B 150°C 3000V FT1 FT2

Application range: The connection cable is for example appropriate to connect converters to electric-mobility test benches. Due to the high voltage rating, the cable can be used for various components and power electronics. The extremely flexible cable design enables an easy laying.

Construction:

Conductor:	bare copper strands, extra fine wires
Core insulation:	Besilen® EI2 acc. to EN 50363-1 + VDE 0207-363-1, orange
Screen:	alu foil and tinned copper braiding
Sheath material:	Besilen® EM9 acc. to EN 50363-2-1 + VDE 0207-363-2-1
Sheath colour:	orange (similar RAL 2004)

Technical data:

Nominal voltage:	Uo/U 1,8/3,0 kV AC Uo/U 2,7/5,4 kV DC
Voltage cULus:	3000 V
Testing voltage:	6500 V
Current-carrying capacity:	acc. to VDE 0298-4
Min. bending radius	
fixed laying:	3 x d
flexible application:	6 x d
Temperature range	DIN VDE cULus: up to +150 °C
fixed laying:	-40/+180 °C
flexible application:	-25/+180 °C
short time use:	+250 °C
Halogen-free:	acc. to IEC 60754-1 + VDE 0482-754-1
Fire performance:	flame retardant and self-extinguishing acc. to IEC 60332-1-2 + VDE 0482-332-1-2, cULus FT1, FT2
Corrosiveness of conflagration gases:	IEC 60754-2 + VDE 0482-754-2 - no development of corrosive conflagration gases
Weather resistance:	very good
Absence of harmful substances:	acc. to RoHS directive of the European Union

Outstanding features:



- extremely flexible
- good EMC characteristics
- halogen-free
- heat resistant
- flexible at low temperatures
- flame retardant and self-extinguishing
- weather resistant
- cULus recognized

item no.	nominal cross section mm²	largest single wire ø mm	ø over inner sheath approx. mm	outer-ø approx. mm	copper figure kg/km	cable weight ≈ kg/km
01100107	1,00	0,07	4,3	7,6	27,2	70
01100157	1,50	0,07	4,7	8,0	34,4	81
01100257	2,50	0,07	5,2	8,5	44,6	96
01100407	4,00	0,07	5,9	9,2	61,3	118
01100607	6,00	0,07	6,3	9,6	83,8	143
01101007	10,00	0,07	8,2	11,7	147,7	222
01101607	16,00	0,07	8,5	12,0	205,7	273
01102507	25,00	0,10	10,9	14,7	307,4	416
01103507	35,00	0,10	12,6	16,3	432,6	548
01105007	50,00	0,10	14,5	18,2	593,6	725
01107007	70,00	0,10	16,5	20,4	804,4	954
01109507	95,00	0,10	18,4	22,3	1064,5	1244
01101207	120,00	0,10	20,1	24,2	1311,0	1514
01101507	150,00	0,10	23,3	27,4	1627,6	1873
01101857	185,00	0,15	24,9	29,2	1970,9	2231
01102407	240,00	0,15	27,5	32,0	2511,2	2841
01103007	300,00	0,15	30,0	34,7	3108,6	3354

Other dimensions and colours are possible on request.



HIGHLY FLEXIBLE HIGH VOLTAGE CABLE

Nominal voltage up to
U₀/U 1.8/3 kV AC

B 110 C

highly flexible Besilen® HV single core, shielded, cULus recognized (as cable harness)

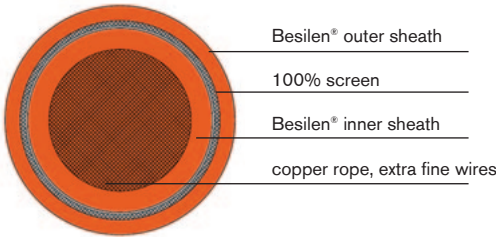
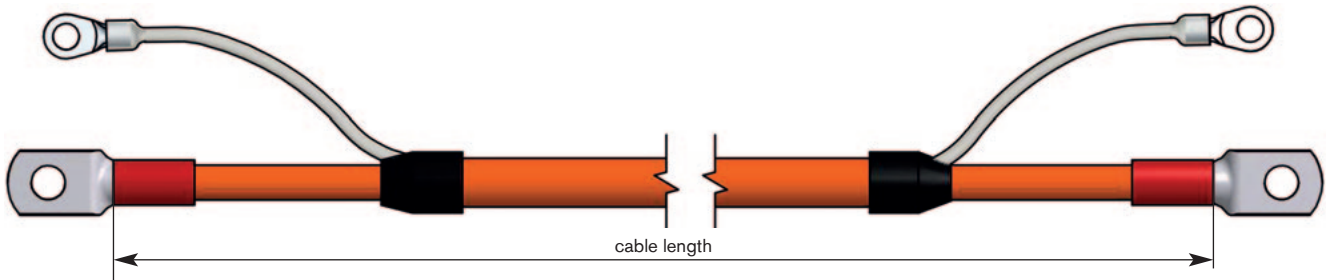

Application range:

for example at HV test benches
for the transmission of high current load

Connection end:

Outer sheath:	50 mm stripped
Connection end 1+2:	tube cable lug (single core) and ring cable lug (screen)
Screen:	led out, twisted and insulated with shrinkable sleeve

Cable data:

Connection cable:	highly flexible HV single core, screened	
Core insulation:	Besilen®	
Screen:	100% screen with alu foil and braiding	
Outer sheath:	Besilen®	
Sheath colour:	orange	
Outer diameter:	see table on page 26	
Nominal voltage:	U ₀ /U 1,8/3,0 kV AC U ₀ /U 2,7/5,4 kV DC	
Voltage cULus:	3000 V	
Temperature range	DIN VDE	cULus: up to +150 °C
fixed laying:	-40/+180 °C	
flexible application:	-25/+180 °C	
short time use:	+250 °C	

CONFIGURATION EXAMPLE

item no.	connection cable length [mm]	stripping lengths + conductor cross section		
		side 1	side 2	cross section
S0110-1006-00075	750	50 mm	50 mm	16 mm ²

Total cable and channel lengths can be realised on customer's request.

SAB identification:

item number, batch number

HIGHLY FLEXIBLE HIGH VOLTAGE CABLE

B 107

highly flexible Besilen® HV single core, unshielded, cULus recognized

Nominal voltage up to
U_o/U 1,8/3 kV AC



0mm² cULus AWM Style 30122 AWM I A 150°C 3000V FT2



Marking for B 107 01079507:

SAB BRÖCKSKES · D-VIERSEN · B 107 U_o/U 1,8/3 kV 95,0mm² cULus AWM Style 30122 AWM I A 150°C 3000V FT2

Application range: The highly flexible single core is particularly appropriate for the application on electric test benches. Due to the fine stranding and the resulting flexibility, the cable can be installed easily. The high voltage single core is designed for a voltage range up to 1,8/3 kV. In this way it fulfils the increasing demands within the voltage class.

Construction:

Conductor:	bare copper strands, extra fine wires
Core insulation:	Besilen® EI2 acc. to EN 50363-1 + VDE 0207-363-1
Sheath colour:	orange (similar RAL 2004)

Technical data:

Nominal voltage:	U _o /U 1,8/3,0 kV AC U _o /U 2,7/5,4 kV DC
Voltage cULus:	3000 V
Testing voltage:	6500 V
Current-carrying capacity:	acc. to VDE 0298-4
Min. bending radius	
fixed laying:	2 x d
flexible application:	4 x d
Temperature range	DIN VDE cULus: up to +150 °C
fixed laying:	-40/+180 °C
flexible application:	-25/+180 °C
short time use:	+250 °C
Halogen-free:	acc. to IEC 60754-1 + VDE 0482-754-1
Fire performance:	flame retardant and self-extinguishing acc. to IEC 60332-1-2 + VDE 0482-332-1-2, cULus FT2
Corrosiveness of conflagration gases:	IEC 60754-2 + VDE 0482-754-2 - no development of corrosive conflagration gases
Weather resistance:	very good
Absence of harmful substances:	acc. to RoHS directive of the European Union

Outstanding features:



- extremely flexible
- halogen-free
- heat resistant
- flexible at low temperatures
- flame retardant and self-extinguishing
- weather resistant
- cULus recognized

item no.	nominal cross section mm ²	largest single wire ø mm	outer-ø approx. mm	copper figure kg/km	cable weight ≈ kg/km
01070107	1,00	0,07	4,3	9,6	25
01070157	1,50	0,07	4,7	14,4	31
01070257	2,50	0,07	5,2	24,0	43
01070407	4,00	0,07	6,3	38,4	60
01070607	6,00	0,07	6,3	57,6	73
01071007	10,00	0,07	9,0	96,0	144
01071607	16,00	0,07	9,3	153,6	194
01072507	25,00	0,10	12,0	240,0	316
01073507	35,00	0,10	13,8	336,0	431
01075007	50,00	0,10	15,7	480,0	591
01075007	70,00	0,10	17,7	672,0	777
01079507	95,00	0,10	18,8	912,0	1033
01071207	120,00	0,10	20,5	1152,0	1280
01071507	150,00	0,10	23,7	1440,0	1602
01071857	185,00	0,15	25,3	1776,0	1936
01072407	240,00	0,15	27,9	2304,0	2509
01073007	300,00	0,15	30,8	2880,0	3003

Other dimensions and colours are possible on request.

for E-Mobility
HV test benches

HIGHLY FLEXIBLE HIGH VOLTAGE CABLE

B 110 C Sense Cable

halogen-free Besilen® Sense cable, shielded, cULus recognized

Nominal voltage up to
U₀/U 1.8/3 kV AC



cULus AWM Style 4659 AWM I/II A/B 150°C 3000V FT1 FT2

Marking for B 110 C Sense Cable:

SAB BRÖCKSKES · D-VIERSEN · B 110 C Sense Cable 2x1,0mm² 0110-9001 cULus AWM Style 4659 AWM I/II A/B 150°C 3000V FT1 FT2

Construction:

Conductor:	bare copper strands, extra fine wires
Core insulation:	Besilen® EI2 acc. to EN 50363-1 + VDE 0207-363-1
Colour code:	black and red
Stranding:	together with , AWG 26
Screen:	alu foil, tinned copper drain wire and tinned copper braiding
Sheath material:	Besilen® EM9 acc. to EN 50363-2-1 + VDE 0207-363-2-1
Sheath colour:	orange (similar RAL 2004)

Technical data:

Nominal voltage:	U ₀ /U 1,8/3,0 kV AC U ₀ /U 2,7/5,4 kV DC
Voltage cULus:	3000 V
Testing voltage:	4000 V
Current-carrying capacity:	acc. to VDE 0298-4
Min. bending radius	
fixed laying:	6 x d
flexible application:	10 x d
Temperature range	DIN VDE cULus: up to +150 °C
fixed laying:	-40/+180 °C
flexible application:	-25/+180 °C
short time use:	+250 °C
Halogen-free:	acc. to IEC 60754-1 + VDE 0482-754-1
Fire performance:	flame retardant and self-extinguishing acc. to IEC 60332-1-2 + VDE 0482-332-1-2, cULus FT1, FT2
Corrosiveness of conflagration gases:	IEC 60754-2 + VDE 0482-754-2 - no development of corrosive conflagration gases
Weather resistance:	very good
Absence of harmful substances:	acc. to RoHS directive of the European Union

Outstanding features:



- extremely flexible
- good EMC characteristics
- halogen-free
- heat resistant
- flexible at low temperatures
- flame retardant and self-extinguishing
- weather resistant
- cULus recognized

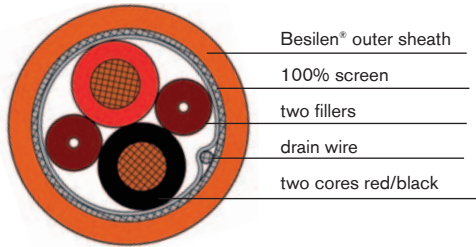

item no.	no. of cores x cross section n x mm ²	core-ø max. mm	outer-ø approx. mm		copper figure kg/km	cable weight ≈ kg/km	ohmic resistance at 20 °C max. Ω/km
01109006	2 x 0,25	3,50	10,2	10,7	32,8	112	80,0
01109007	2 x 0,34	3,60	10,6	11,1	53,5	130	58,8
01109008	2 x 0,50	3,80	11,1	11,7	57,3	142	39,0
01109001	2 x 1,00	4,35	12,1	12,7	72,7	170	20,0
01109002	2 x 1,50	4,75	12,9	13,5	90,1	198	13,3
01109003	2 x 2,50	5,25	13,9	14,6	111,0	238	7,98
01109004	2 x 4,00	5,95	15,3	16,1	146,5	297	4,95
01109005	2 x 6,00	6,35	16,3	17,1	216,3	365	3,3

Other dimensions and colours are possible on request.

Possible on request:

As harnessed cable
acc. to customer's specification

HV test adapter

 scoop-proof area

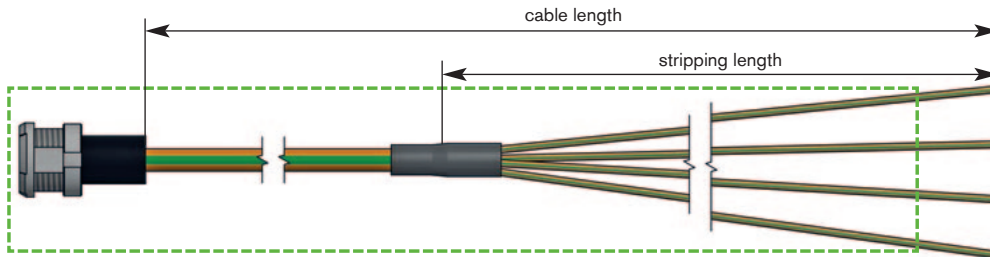

 **For all sensor types available!**

e.g. HV test adapter for HV 4-channel type K sensors

4-channel type K



1-channel type K



2-channel PT100

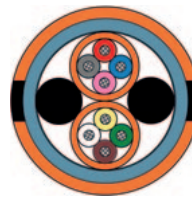

strain gauge



Application range: The HV test adapter is used for the adaptation of HV sensors in fixed installation and are available for all sensor types in high voltage environments. The connection to test installed sensors for potential compensating measurements or the fixed installation in empty housings are only some of the application fields for which a test adapter can be used.

Application range:

for example to test installed HV sensors

Connector:

Lemo Redel 2P apparatus socket with black potting sleeve, 8-pole, coding acc. to sensor type
1000 V AC voltage-proof
– only suitable for fixed installation.

Connection end:

stripping length acc. to customer's request /
open end: 2 mm
dimensions for mounting cut-out on request

Cable data:

Description:	high voltage cable acc. to sensor type
Core insulation:	FEP
Inner sheath:	PUR – blue acc. to RAL 5024
Outer sheath:	PUR
Sheath colour:	orange with vertical stripes (black or green)
Stranding:	paired construction (for EMC)
Outer diameter:	depending on the used cable
Dielectric strength:	1000 V AC – depending on the used cable
Temperature range	
fixed laying:	-50°C / +150°C
flexible application:	-40°C / +150°C

Tests:

► Cable test

core/core – 600 V AC - 1 min - acc. to IEC 60584-1
over pair sheath/inner sheath in water bath –
5000 V AC – 5 min – with reference to EN 50264-2-1

► Product test

routine test of harnessed connector
with reference to standard 61010-1 for measuring devices
as well as VDE indications in our in-house ball bath
(released by VDE). Control of contact protection
towards outside – 3000 V/1 min AC

Issue of HV test certificate with reference to batch number due to optimum traceability

Optional: Test and repair of already used sensors on request

CONFIGURATION EXAMPLES

item no.	connection cable length	single channel length	type
T141-056-583	115 mm	100 mm	4 x type K
T141-055-568	200 mm	50 mm	1 x type K
T641-057-773	150 mm	100 / 50 mm	2 x PT100/PT1000 analogue (90V)
T644-062-235	115 mm	100 mm	strain gauge
T645-xxx-xxx	115 mm	100 mm	voltage (90V)
T645-xxx-xxx	155 mm	100 mm	voltage (1000V)

SAB identification:

item number, batch number

Total cable and channel lengths can be realised on customer's request.

Accessories

Application range:

HV cap

HV cap black, universally coded with fixing cord for HV connector.

CONFIGURATION EXAMPLES

item no.	configuration
T021-061-745	plug
T021-062-719	socket



Application range:

dual shrinkable sleeve

Dual shrinkable sleeve natural, PTFE/FEP, Ø before shrinking 1,65 mm - Ø after shrinking 0,00 mm -190°C up to +200°C (for example for the later insulation of measuring tips)

CONFIGURATION EXAMPLE

item no.	configuration
T020-024-319	1000 mm



Application range:

spare pads

Replacement of adhesive pads to apply the measuring tip on surfaces.

CONFIGURATION EXAMPLES

item no.	configuration
T095-044-258	glass cloth 25 x 25
T095-056-403	PI foil 12,5 x 25

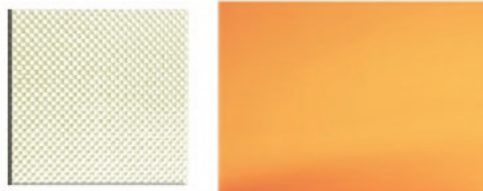

Application range:

automatic hinged cover

Conversion kit to automatic hinged cover for Redel socket / size 2P to protect the socket from dust, dirt and moisture

CONFIGURATION EXAMPLE

item no.	configuration
T021-060-467	conversion kit



Application example for high voltage measuring cables

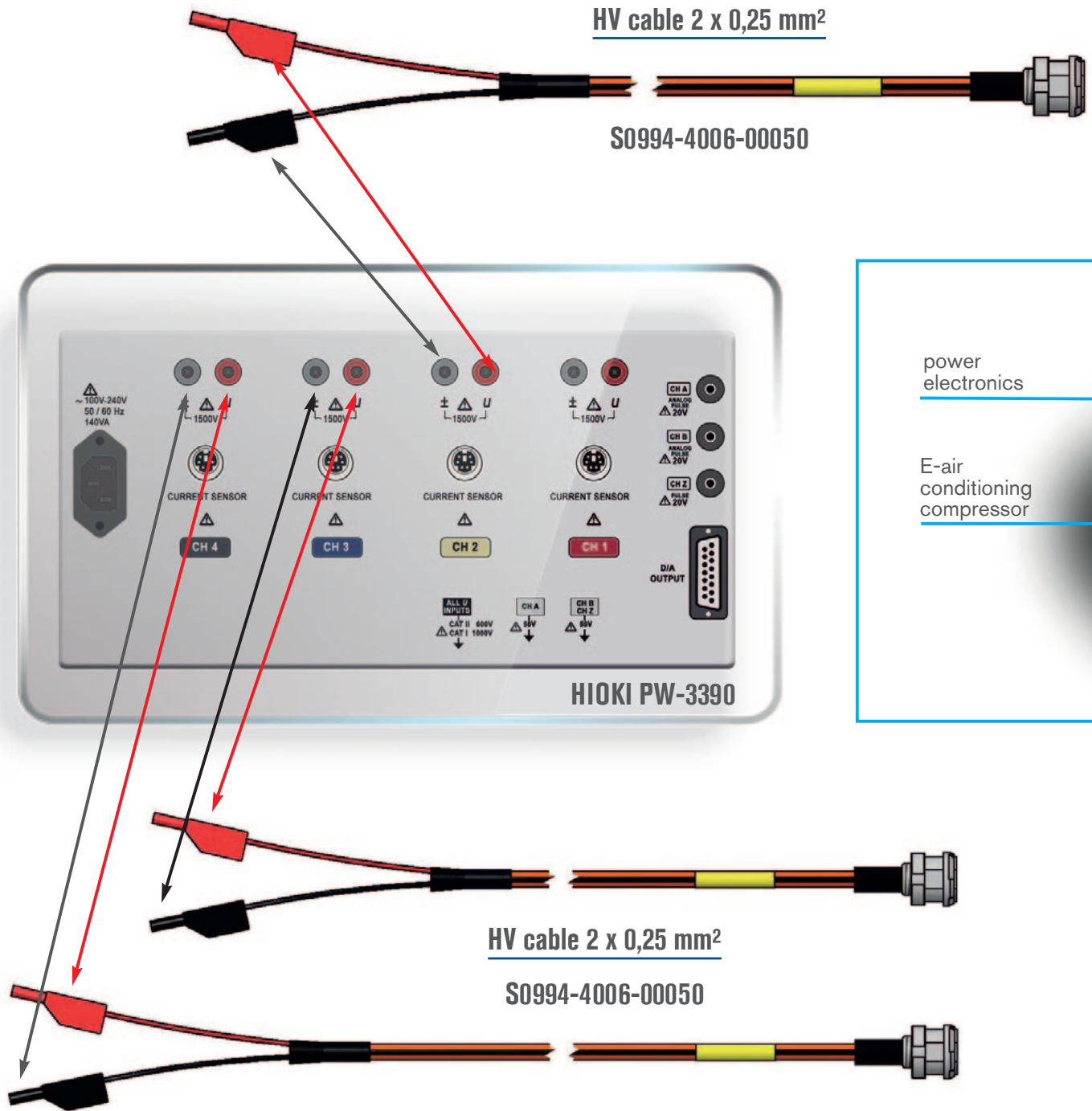

LV cable 2 x 0,5 mm² screened



ELECTRIC VEHICLE

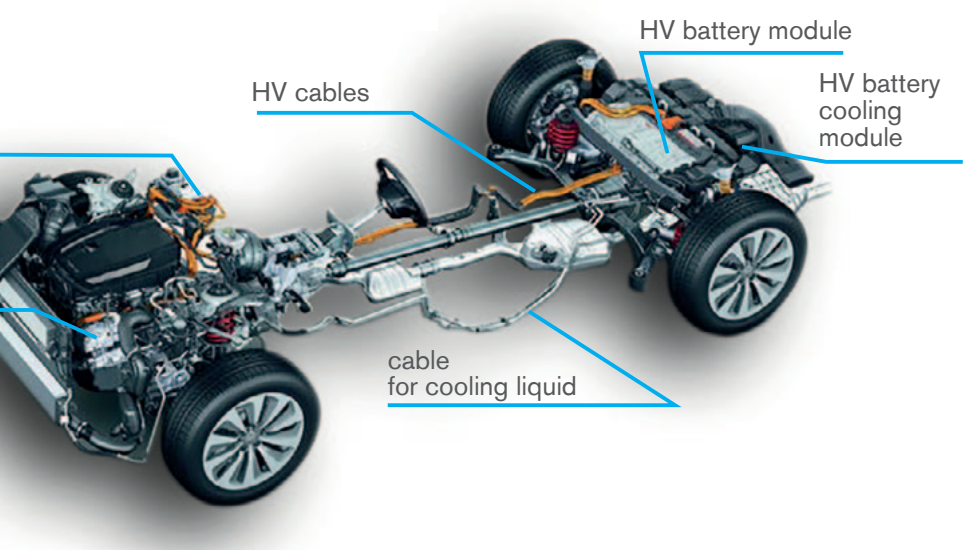

LV connection

(e.g. 12V vehicle battery)

HV adapter with clamping points

(vehicle specific)

HV cable 2 x 0,25 mm² screened

S3833-3002-00015



connection box with Redel socket and 2 connection cables with Redel plug

HV cable 2 x 0,25 mm² screened

T641-060-343

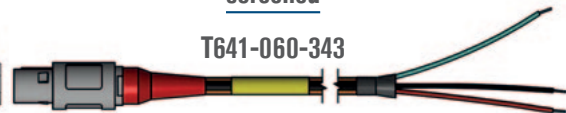

extension

T641-061-127



S3833-3003-00025

connection box with Redel socket and 3 connection cables with Redel plug

Glossary

⦿ AC voltage

Alternating current (AC) refers to a type of electric current that changes its direction periodically and in constant repetition. Alternating current is often used for electrical energy supply. It flows through high-voltage lines and reaches ordinary households via socket.

⦿ Bipolar (unipolar)

In connection with SAB HV sensors unipolar is the voltage that in contrast to real direct voltage – does not change sign but has got an alternating value. In fact it is a mixture out of direct and alternating voltage. In contrast to unipolar, bipolar means that the sign of voltage can change.

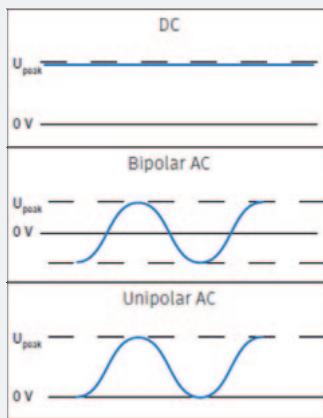

⦿ Breakdown voltage

The breakdown voltage is the voltage required to allow current to flow through an insulator. This results in an electrical voltage breakdown. In a statistical series of breakdown voltage tests, this is the upper limit of the measured values.

⦿ DC voltage

Direct current (DC) refers to electrical current whose strength and direction do not change over time. Batteries and solar cells, for example, supply direct current.

⦿ Dielectric strength

The dielectric strength (usually specified in kV/mm) of an insulator is the maximum electric field strength that may prevail in the material without a voltage breakdown (arc or spark) occurring. In a statistical series of breakdown voltage tests, this is the lower limit of the measured values.

⦿ High voltage

An electrical voltage above 1000V AC or 1500V DC is generally referred to as high voltage. In the VDE regulations, standardised voltages up to 1kV are referred to as low voltage and over 1kV as high voltage. In electrical power engineering, further conceptual subdivisions of high voltage into the sub-

terms „medium voltage“, „high voltage“ and „extra-high voltage“ are common, although the limits are not standardised. In the context of this glossary, „high voltage“ refers to the 60 kV and 110 kV range for supplying smaller towns, overland supply and the connection of smaller power stations.

Within the range of electrical technology in vehicles we also talk about high voltage. When the term „high voltage“ (HV for short) is used, it clearly refers to a voltage in motor vehicles that is higher than 25V (AC) or higher than 60V (DC). The reason for this is that the term „high voltage“ clearly indicates the potential danger.

⦿ HV identification

The term HV identification refers to the labelling of the cables and connection components of the HV sensors. The connection component is labelled with an orange bend protection sleeve and a „Danger“ label, the measuring cable with a corresponding identification strip in orange. This signal colour warns of the new sources of danger in hybrid and electric vehicles. The use or marking with the colour orange (known as „high-voltage orange“) can be found in the ISO 6469-3 and ECE-R 100 standards.

⦿ Insulated measuring tip

With the „insulated measuring tip“, the bare measuring tip is hermetically sealed. The insulation at the bare point (measuring tip) is stronger than the basic insulation, but weaker than the reinforced insulation. However, it fulfils the criteria for a dielectric strength of 1000V AC and is considered as scoop-proof.

With the „mechanically insulated measuring tip“, the bare measuring tip is provided with additional basic insulation, but this is open on the side of the measuring tip. It offers no protection against accidental contact, but fulfils the criteria for 1000V AC. If the insulation fails, there is no additional protection in the area of the measuring tip.

⦿ Insulation

Basic insulation:

Insulation of dangerously active parts that ensures basic protection.

Additional insulation:

Independent insulation applied in addition to the basic insulation to ensure protection against electric shock in the event of failure of the basic insulation.

Double insulation:

Insulation consisting of the basic insulation and the additional insulation.

Reinforced insulation:

Insulation that provides protection against electric shock that is not less than the protection provided by the double insulation.

Glossary

⊙ Leakage distance (acc. to IEC 61010-031)

The leakage distance is the shortest distance along the surface of a solid insulating material between two conductive parts. The leakage distance for measuring accessories means the shortest distance along the surface of an insulating material between a part that is dangerous to touch and a part of the user's body.

⊙ Nominal voltage

The nominal voltage is the basis of assessment for our items. Certain operational characteristics refer to this nominal voltage.

⊙ Operating voltage (in accordance with EN 61010-031)

Highest effective value of the direct or alternating voltage that can be permanently applied to an insulation during normal operation.

⊙ Protection against contact

Constructive precautions at electric operating equipment that protect against hazardous contact with energized components (for example insulation). The term „contact protection“ is related to voltage rating that indicates the upper limit of electric voltage with which measuring equipment can be operated safely. This upper limit (nominal voltage) depends on the operational environment of the measuring accessories.

⊙ Recognised rules of technology

The (generally) recognised rules of technology are technical rules or guidelines for the design and execution of structural or technical objects. These are rules that are recognised as theoretically correct and established in science, as well as being known in practice by technicians trained in accordance with the latest state of knowledge and have proven themselves on the basis of continuous practical experience. The generally recognised rules of technology are not identical to standards.

⊙ Routine test

Conformity tests on each individual unit during or after production.

⊙ Scoop-proof

The indication „scoop-proof“ means in connexion with our SAB HV sensors the following:

The item has been designed and tested in a way that there is no risk of an electric shock for the user if he touches the cable under condition that the measuring tip is conductively connected with a component that does not exceed the indicated nominal voltage. Herewith, it is always indicated until which point or layer safety is guaranteed. Some items have for example a coloured inner sheath that indicates when

mechanical wear threatens the safety described before. Other multi pair cables have partial elements. Here the pairwise insulation already fulfils the safety requirements.

Due to the risk to mix it up with the normative term „tangible“, the term „voltage-proof“ is preferred for this characteristic as it is not used in standards.

⊙ Sparking distance in air (acc. to IEC 61010-031)

The sparking distance in air is defined as the shortest distance in air between two conductive parts.

⊙ Standard test finger

The purpose of the test finger is to simulate the non-touchability of active parts by the human finger. The dimensions are specified in EN 61010-031. A distinction is made between rigid test fingers and articulated ones.

⊙ Tangible (with regard to one part) (acc. to EN 61010-031) (please see also „scoop-proof“ and „voltage-proof“)

Conditioned in a way that it can be touched by a standardized test pin. This term could be confused with the term „scoop-proof“.

⊙ Testing voltage

Testing voltage is the voltage that a test specimen (connector, cable, other components) can withstand without breakdown or flashover when handled as specified. This voltage is significantly higher than the specified nominal voltage.

Common scales are $2xU_{\text{nom}} + 1000V$.

⊙ VDE

The VDE, originally Verband Deutscher Elektrotechniker (Association of German Electrical Engineers), since 1998 the Association for Electrical Engineering, Electronics and Information Technology is committed to the sciences in these fields and the technologies based on them. The VDE's work focuses on safety in electrical engineering, the development of recognised rules of technology as national and international standards and the testing and certification of devices and systems.

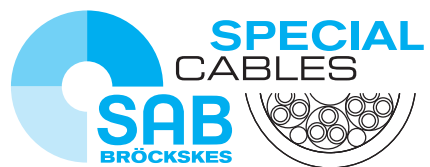

SAB Bröckskes GmbH & Co. KG

Grefrather Str. 204 - 212 b

41749 Viersen · GERMANY

Tel.: +49/2162/898-0

Fax: +49/2162/898-101

www.sab-cable.com

info@sab-cable.com